

9095X Overfill Prevention Valve

Installation & Maintenance Instructions

The 9095X Overfill Prevention Valve is installed at the fill port of a storage tank. Used in a pressurized tight fill application, the valve helps prevent tank overfills by closing when the liquid level reaches a pre-set warning level (90-95% full). The valve is installed through a 4" threaded opening and has a built-in bleed hole that allows the fill hose pressure to be relieved after the valve closes. When installed to manufacturer requirements, the Morrison Fig. 9095X Overfill Prevention Valve can eliminate hazardous liquid spills.



Failure to follow any or all of the warnings and instructions in this document could result in a hazardous liquid spill, which could result in property damage, environmental contamination, fire, explosion, serious injury or death.

Installation



WARNINGS

- **Fire Hazard** – Death or serious injury could result from spilled liquids.
- Any modification to this valve other than stated in these installation instructions will void the product warranty.
- This device is intended to be used only as a secondary shutoff and should not be the only system in place to prevent a tank from overflowing. It is the sole responsibility of the operator to continuously prevent any spillage regardless of the situation or status of the valve.
- The valve must be used with clean product. Contamination suspended in the liquid may cause the valve to function improperly. Line strainers or filters should be used in the fill piping or delivery vehicle to insure clean product.
- Minimum requirements for valve operation: 5 GPM inlet flow at 5 PSI inlet pressure.
- Maximum pressure is 100 PSI.
- Maximum allowable viscosity is 300 centistokes.
- A tight fill is required for the valve to operate. Do not substitute any other fill adaptors for the special adaptor supplied.
- Once closed the valve will allow flow of less than 2% of max flow to relieve fill line pressure.
- All by-pass and or limit valves of the delivery system must be functional and properly set prior to filling.
- Install in accordance with all applicable local, state, and federal laws.
- For your safety, it is important to follow local, state, federal and/or OSHA rules that apply to working inside, above, or around the storage tank and piping area. Use all personal protective equipment required for working in the specific environment.
- Tanks could be under pressure. Vapors could be expelled from tank vents, piping, valves or fittings while performing installation. Vapors could catch fire or cause an explosion. Avoid sparks, open flame, or hot tools when working on valves.
- Fill points should be labeled to identify product being transferred according to all applicable codes.

Steps

1. Remove the valve from the box and remove all packaging material. Check the valve for any shipping damage. Remove the adaptor and nipple from the valve. Check for freedom of plunger movement by securing float, turning unit upside down, and looking through the body opening at the plunger. The plunger should slide freely to contact the seal surface of the body and drop back down into the dashpot when turned to the upright position. Set the valve upright and move the float up and down to insure there is no binding.

- Determine the SHUT-OFF DISTANCE at 90 or 95% full. (See Fig. 1 & Mfg. tank ullage chart). Record this distance as you will need it later when installing the valve.
- Refer to Fig. 2 or Fig 4, depending on your float type. Select the measurement for the fuel you will be storing. Using a ruler, measure up from the bottom of the float and mark a line on your float at that measurement. Use a wax pen or chalk to mark the line.

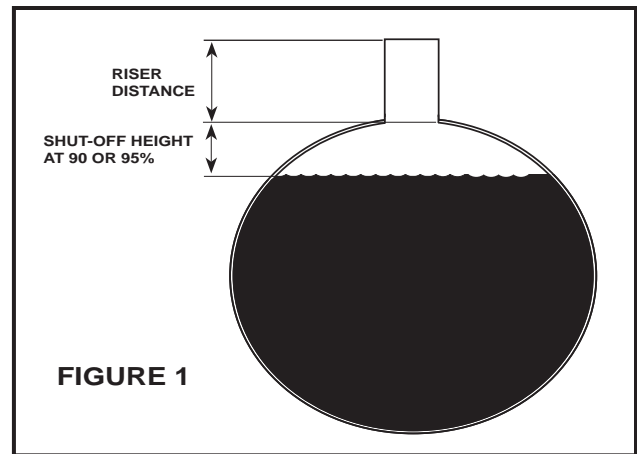

FIGURE 1

Note: If you are storing a liquid, other than those noted in Fig. 2, and the specific gravity of your liquid is not the same as one of the liquids shown, you can use the calculation, shown at the end of this document, to determine the measurement to mark your float.

- Measure from the top of the tank up to the point where the valve is to be attached. This is your Riser Distance shown in Fig. 1. Record this length. **Note:** this distance needs to include all pipe fittings, spill containers, etc. all the way up to the point where the valve is to be attached.
- Move your float into the up position. Now the line that you marked on the float (Step 2) is at the point where the valve will shut off during the filling process. Measure from the line on the float all the way up to the point where the valve will thread onto the piping. We will call this Length X (See Fig. 3) Record this length.
- Now you can make piping adjustments to insure that the line on the float will be in the tank at your desired shut off point when the unit is installed into the tank. To make these adjustments you can change the Riser Distance shown in Fig. 1. Lastly, you can make minor adjustments by moving the floats up or down. To do this loosen the allen screws on the float adjustment collars, shown in Fig. 3, move the floats up or down, and then tighten the allen screws.

Important: After making your adjustments in Step 6, the Riser Distance (Step 4) **plus** your Shut-off Distance (Step 2) should be **equal to** Length X (Step 5).

Important: If adjustments are made to the float adjustment collars, you must set the valve in the upright position and move the float up and down to insure there is no binding.

- Use care with floats and linkage during installation. Apply a non-hardening gasoline resistant sealant sparingly to all male threads. Attach the drop tube to the bottom of the valve. Assemble piping and install valve in the tank to distance determined in the steps above.

Caution: Excessive use of thread sealant may cause the valve to function improperly, application of thread sealant should be to male threaded members of the system only (to reduce the possibility of sealant being forced inside the system).

Important: Attach warning tag at fill point, with supplied cable tie, in location visible to operator filling the tank.



Failure to follow any or all of the warnings and instructions in this document could result in a hazardous liquid spill, which could result in property damage, environmental contamination, fire, explosion, serious injury or death.

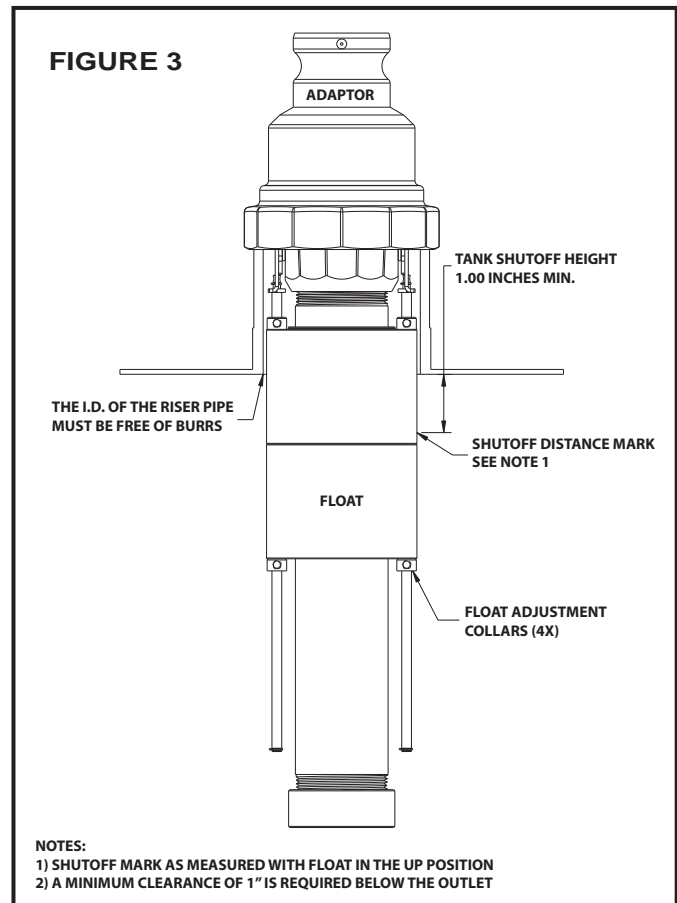
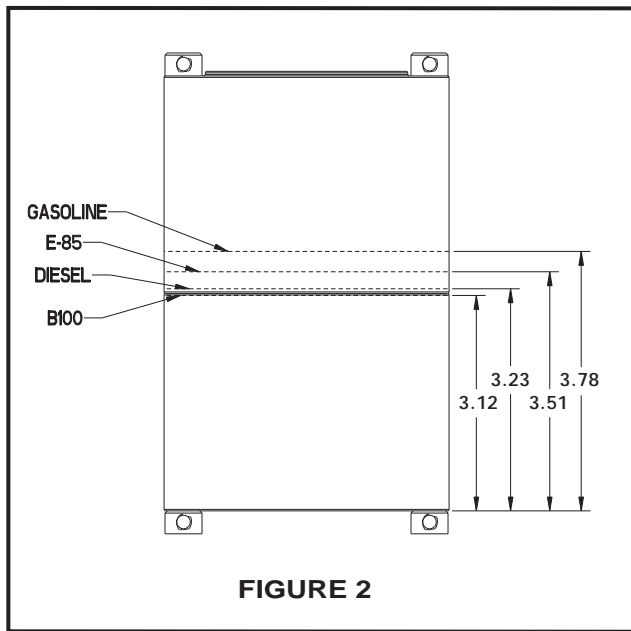

Filling Procedure

1. Make sure the fill nozzle is equipped with the appropriate mating coupler to form a secure connection with the tight fill adaptor.
2. Attach the nozzle to the tight fill adaptor making sure the connection is secure.
3. Switch on the pumping system.
4. Gradually open the fill nozzle and begin product transfer.
5. Continuously monitor tank filling process.
6. If the liquid level reaches the preset level of the 9095X valve, and the valve shuts off, the operator may see a slight movement of the fill hose and/or hear the pump by-pass activate.
7. If the 9095X shuts off during the tank fill, perform the overfill disconnect procedure.

Overfill Disconnect Procedure

1. If 9095X shut-off has occurred, close the fill nozzle immediately.
2. Turn off the pumping system.
3. Slowly release one arm of the quick coupler. This will introduce air into the fill line and allow product between nozzle and valve to drain. Wait a minimum of (1) minute for product to drain.
4. Completely uncouple and remove the nozzle after the line has drained. Attempting to disconnect the coupler from the tight fill adaptor with pressure in the hose will result in a product spill.



Failure to follow any or all of the warnings and instructions in this document could result in a hazardous liquid spill, which could result in property damage, environmental contamination, fire, explosion, serious injury or death.

Maintenance

This valve should be maintained according to local codes or to API Recommended Practice 2350.



WARNINGS

- **Fire Hazard** – Death or serious injury could result from spilled liquids.
- You must be trained to maintain this valve. Stop now if you have not been trained.
- For your safety, it is important to follow local, state, federal and/or OSHA rules that apply to working inside, above, or around the storage tank and piping area. Use all personal protective equipment required for working in the specific environment.
- Tanks could be under pressure. Vapors could be expelled from tank vents, piping, valves or fittings while performing maintenance. Vapors could catch fire or cause an explosion. Avoid sparks, open flame, or hot tools when working on valves

If valve is to be inspected, please do the following:

1. Remove valve from the tank.
2. Inspect the float and float linkages for any damage and make sure the float can move up and down freely. If the float or the float linkages have been damaged, or the float cannot move up and down freely, the valve must be sent back to the factory for evaluation.
3. Look down into the top of the valve to inspect for any debris or foreign objects that may have entered the valve. If you can see any debris or foreign objects, the valve must be returned to the factory for evaluation.
4. Check for freedom of plunger movement by securing float, turning unit upside down, and looking through the body opening at the plunger. The plunger should slide freely to contact the seal surface of the body and drop back down into the dash pot when turned to the upright position. You may also hear a clunking/clicking sound when turning valve upside down and right side up. If you cannot see the plunger move freely or if this clunking/click sound is not present, it may indicate that the valve plunger is stuck and the valve must be returned to the factory for evaluation.
5. Inspect the vent warning tag located near the tank fill point. If the tag is damaged or difficult to read, contact Morrison Bros. Co. at (800) 553-4840 for a free replacement tag.



Failure to follow any or all of the warnings and instructions in this document could result in a hazardous liquid spill, which could result in property damage, environmental contamination, fire, explosion, serious injury or death.

Calculation for shut-off point for liquids with specific gravities different than those shown in Fig. 2.

$$\text{Shut-off point distance} = ((1 - \text{Specific Gravity}) \times 4.0) + 2.75$$

Measure this distance up from the bottom of the float and mark as indicated in steps 3 & 4 of the installation steps and then follow the rest of the installation Steps.