



TopKAT™ Fuel Management System

Operation Manual

Computer Programs and Documentation

All Gasboy computer programs (including software on diskettes and within memory chips) and documentation are copyrighted by, and shall remain the property of, Gasboy. Such computer programs and documents may also contain trade secret information. The duplication, disclosure, modification, or unauthorized use of computer programs or documentation is strictly prohibited, unless otherwise licensed by Gasboy.

Federal Communications Commission (FCC) Warning

This equipment has been tested and found to comply with the limits for a Class A digital device pursuant to Part 15 of the FCC Rules. These limits are designed to provide reasonable protection against harmful interference when the equipment is operated in a commercial environment. This equipment generates, uses, and can radiate radio frequency energy, and if not installed and used in accordance with the instruction manual, may cause harmful interference to radio communications. Operation of this equipment in a residential area is likely to cause harmful interference in which case the user will be required to correct the interference at his own expense. Changes or modifications not expressly approved by the manufacturer could void the user's authority to operate this equipment.

Approvals

Gasboy, Greensboro, is an ISO 9001:2000 registered facility.

Underwriters Laboratories (UL):

UL File#	Products listed with UL
MH4314	All dispensers and self-contained pumping units
MH6418	Power operated Transfer Pump Models 25, 25C, 26, 27, 28, 72, 72S, 72SP, 72X, 73 and 1820
MH7404	Hand operated Transfer Pump Models 1230 Series, 1243 Series, 1520 and 1720 Series
MH10581	Key control unit, Model GKE-B Series Card reader terminals, Models 1000, 1000P Site controller, Model 2000S CFN Series Data entry terminals, Model TPK-900 Series Fuel Point Reader System

New York City Fire Department (NYFD):

NYFD C of A #	Product
4823	9100A, 9140A, 9152A, 9153A, 9800A, 9840A, 9850A, 9852A, 9853A, 9140
4997	9822A, 9823A
5046	9100Q, 9140Q, 9152Q, 9153Q, 9800Q, 9840Q, 9852Q, 9853Q
5087	8753K, 8853K, 9153K, 9853K (restricted to diesel and non-retail gasoline sales)
5091	8752K, 9152K
5129	9122K, 9123K, 9822K, 9823K

California Air Resources Board (CARB):

Executive Order #	Product
G-70-52-AM	Balance Vapor Recovery
G-70-150-AE	VaporVac

National Conference of Weights and Measures (NCWM) - Certificate of Compliance (CoC):

Gasboy pumps and dispensers are evaluated by NCWM under the National Type Evaluation Program (NTEP). NCWM has issued the following CoC:

CoC#	Product	Model #	CoC#	Product	Model #	CoC#	Product	Model #
95-179	Dispenser	9100 Retail Series, 8700 Series, 9700 Series	91-019	Dispenser	9100 Commercial Series	05-002	Atlas	8700K, 8800K, 9100K, 9200K, 9800K
95-136	Dispenser	9800 Series	91-057	Controller	1000 Series FMS, 2000S-CFN Series			

Patents

Gasboy products are manufactured or sold under one or more of the following US patents:

Dispensers

5,257,720

Point of Sale/Back Office Equipment

D335,673

Additional US and foreign patents pending.

Trademarks

Non-registered trademarks

Atlas™
Console™
Infinity™

Registered trademarks

ASTRA®
Fuel Point®
Gasboy®
Keytrol®
Slimline®

Additional US and foreign trademarks pending.

Other brand or product names shown may be trademarks or registered trademarks of their respective holders.

Table of Contents

1 – Introduction	1
Abbreviations and Acronyms	2
Warranty	4
2 – Important Safety Information	5
3 – System Overview	9
Hardware Description	9
CPU Printed Circuit Board	10
CPU PCB Switch Settings	10
CPU LEDs	11
Battery Maintenance/Replacement	12
Communications	12
Communications Ports	12
Communications Protocol	12
Initiating Communications	13
Operating Modes	13
9800 Switch Settings	13
Report Printer Interface Option - Standalone or Master Only	15
Accessing the Printer	15
Printer Controller PCB	15
Setting Switches	16
Adjusting Contrast	16
Loading Paper	17
PCMCIA Interface Option - Standalone or Master Only	18
PCMCIA Interface PCB	18
Master/Satellite (T/Net) Option	19
Mechanical Interface Option	20
Hardware	20
Software	20
Mechanical PCU Option	21
Hardware	21
Software	21
Typical Fueling Sequence - Standalone or Master/Satellite	22
Delivery or Dipstick Key Sequence	24
Supervisor Key Sequence	24
4 – Getting Started/System Setup	25
Setting Up the System	25
Navigating the Keypad	25
Setting Up Your System for the First Time	26
Keypad Setup for Standalone or Master Mode	26
Keypad Setup for Satellite Mode	28
Terminal Mode Setup	29
Accessing the Main Menu Options	30
Setup Menu	30
Accessing the Setup Commands	30

5 – Vehicle File Setup - Keypad **35**

About the Vehicle File	35
Limitation Codes	36
Authorization Codes	37
Check Digit	37
Lockout	38
PIN	38
Vehicle Record Maintenance	39
Edit/View Record	39
Add Vehicle Record	39
Delete Vehicle Record	40
Encode Key	41
Initialize File	42
Clear File	42

6 – Manual Entry File Setup - Keypad **43**

About the Manual Entry File	43
Manual Entry File Maintenance	44
Accessing the Manual Entry File	44
Edit/View Manual Entry	44
Add Manual Entry Record	44
Delete Manual Entry Record	45
Initialize File	45
Clear File	45

7 – Tank, Pump, and PCU File Setup - Keypad **47**

About the Tank File	47
Access the Tank File	47
Load # of Tanks	47
Initialize File	48
Load Tank Table	48
Add to Inventory	48
Subtract from Inventory	49
About the Pump File	49
Access the Pump File	49
Initialize File	49
Load # of Pumps (Standalone TopKAT, Master Electronic, Master Mechanical PCU)	50
Load Base Pump (Standalone TopKAT and Master Electronic, Master Mechanical PCU)	50
Load Pump Table	50
Load Pump Timeouts	51
About the PCU File	52
Access PCU Setup	52
PCU Setup/PCU Assignments (Standalone, All Electronic; Master, All Electronic; Mechanical PCUs)	52
PCU Assignments/Edit PCUs (Master Mechanical I/F, Master Combination)	53

8 – Transaction File Setup - Keypad	55
<hr/>	
About the Transaction File	55
Config Trans File	56
Move Trans Pointer	56
Load Trans Number	56
Clear Trans in Prog	56
Clear Trans File	56
Record Error Trans	57
Config Trans Logger	57
Memory Full Protection	57
9 – Modem Initialization - Keypad	59
<hr/>	
About Modem Initialization	59
PRINT MODEM INIT	60
INIT MODEM	60
10 – Serial-to-LAN Configuration	61
<hr/>	
11 – Wireless Communications Configuration	63
<hr/>	
12 – Reports	65
<hr/>	
About Reports	65
Printing Reports	65
Accessing the Report Menu	65
Print Date/Time	66
Print System Configuration (PRINT SYS CONFIG)	66
Department/Vehicle Report (DEPT/VEHICLE RPT) or Account Vehicle Report (ACCT/VEHICLE RPT)	66
Inventory Report	67
Pump Report	67
Vehicle File Report (VEH FILE REPORT)	68
Vehicle Lockout Report (VEH LOCKOUT REPORT)	68
Manual Entry Lockout Report (MAN LOCKOUT REPORT)	68
Department Manual Entry Report (DEPT MAN ENT RPT)	69
Manual Entry Report	69
Events Report	70
13 – Diagnostics and Utilities	71
<hr/>	
About Diagnostics and Utilities	71
Accessing the Keypad Diagnostics Menu	72
Keypad Diagnostics Menu	72
Keypad: PCU STATUS	72
Keypad: RAM TEST	72
Keypad: ROM TEST	72
Keypad: DIP SWITCH TEST	73
Keypad: KEYPAD TEST	73
Keypad: DISPLAY TEST	73
Keypad: KEY READ TOTALIZER	73
Keypad: PROGRAM VERSION	74
Keypad: PORT TEST	74

Keypad: DATAKEY READ	74
Keypad: PCMCIA TEST	75
Accessing the Utilities Menu.	75
PCMCIA Backup/Restore Utility (optional)	76
Accessing the Terminal Diagnostics Menu.	79
Terminal: RAM TEST	80
Terminal: ROM TEST	80
Terminal: DIP SWITCH TEST	81
Terminal: HEALTH LIGHT TEST	81
Terminal: BEEPER TEST	82
Terminal: DISPLAY TEST	82
Terminal: KEYPAD TEST	83
Terminal: DATAKEY TEST	83
Terminal: PORT TEST	83
Terminal: DEADMAN TIMER RESET	84
Terminal: PCMCIA TEST	85
Terminal: PRINTER TEST	86

14 – Terminal Commands 87

About Terminal Commands	87
Accessing the Terminal Commands.	88
Add Inventory (A I)	88
Add RECOrd (A REC)	89
CLear File (CL F)	90
CLear Key (CL K)	90
CLear Transaction In Progress (CL TIP)	90
COntfigure Bulk (CO B)	91
COntfigure LOGger (CO LOG)	91
COntfigure MAAnual (CO MA)	91
COntfigure PCUs (CO PC) - Standalone Electronic; Master/Satellite Electronic; Mechanical PCUs	92
COntfigure PCus (CO PC) - Master/Satellite Mechanical; Master/Satellite Combination	92
COntfigure PIn (CO PI)	94
COntfigure SYStem (CO SY) - Standalone Electronic or Mechanical PCU	94
COntfigure SYStem (CO SY) - Standalone Mechanical	95
COntfigure SYStem (CO SY) - Master/Satellite Mechanical; Master/Satellite Combination	96
COntfigure SYStem (CO SY) - Master/Satellite Electronic or Mechanical PCU	97
COntfigure Units (CO U)	98
DElete RECOrd (DE REC)	98
DIAGNostics (DIAG)	99
DISable PUmp (DIS PU)	99
EDit RECOrd (ED REC)	99
ENable PRotection (EN PR)	100
ENable PUmp (EN PU)	100
EXit (EX)	100
Help (H)	100
INitialize File (I F)	101
Initialize MODem (I MOD)	101
Load DAte (L DA)	102
Load MODem (LO MOD)	102

Load MOre (L MO)	102
Load PAssword (L PA)	103
Load PUmp (L PU)	103
Load RAnge (L RA)	103
Load RETry (L RET)	104
Load TAnk (L TA)	104
Load TIMe (L TIM)	104
Load TRansactions (L TR)	104
Move POnter (M PO)	105
PRint DAtE (PR DA)	105
PRint DEPTMan (PR DEPTM)	105
PRint DEPTVeh (PR DEPTV) or PRint Acctveh (PR A)	106
PRint EVents (PR EV)	106
PRint KEy (PR KE)	106
PRint LOckout (PR LOC)	107
PRint MAnnual (PR MA)	107
Print MODem (P MOD)	107
PRint PUmp (PR PU)	107
PRint SYstem (PR SY)	108
PRint TAnks (PR TA)	108
PRint TRansaction (PR TR)	108
PRint VehIcle (PR V)	108
REcord ERror (RE ER)	108
RUN (RUN)	109
SElect Name (SE N)	109
STOP (STOP)	109
SUbject Inventory (SU I)	110

Appendix A: HELP Command	A-1
------------------------------------	-----

Appendix B: Menu Flow Chart	B-1
---------------------------------------	-----

Appendix C: Display Messages	C-1
--	-----

Appendix D: Transaction Error Codes	D-1
---	-----

Appendix E: Loading TopKAT Files from Microsoft® Excel®	E-1
---	-----

Creating Your TopKAT Vehicle Records in Excel	E-1
Sequential Numbering Hint	E-3
Transferring Vehicle Records from Excel to TopKAT	E-4
Reasons for Errors	E-6
Creating Your TopKAT Manual Entry Records in Excel	E-7
Transferring Manual Entry Records from Excel to TopKAT	E-8

Index	Index-1
-----------------	---------

This page is intentionally left blank.

1 – Introduction

The Gasboy TopKAT is a microprocessor-based fuel control and data acquisition system, mounted on top of a 9800 pump/dispenser or on a pedestal with the 9820 ASTRA® or mechanical pump/dispenser, that is designed to gather and record specific information about your fuel management operation as well as provide unattended access to your fuel site.

Figure 1-1: Typical TopKAT Installation



Access to the system is controlled by vehicle code keypad entry (also called keyless entry) or by special data keys that relate to vehicle file records maintained on the system. There are six possible key types available:

- Vehicle: Key type 0. Linked to the vehicle that will be fueling and the department to which it belongs. This is the most common key for accessing fuel.
 - Supervisor: Key type 3. Provides access for fueling by a supervisor manually entering a key number or a vehicle number and department number.
 - Manager: Key type 8. Provides access to system configuration and setup functions, utilities and diagnostics, and reports.
 - Report*: Key type 9. Provides access to report printing capabilities, while restricting access to other manager functions.
 - Dipstick*: Key type 5. Allows dipstick readings to be entered at the TopKAT keypad.
 - Delivery*: Key type 4. Allows delivery transactions to be entered at the TopKAT keypad.
- * Available for use at standalone TopKAT or TopKAT master unit.

There are six possible system configurations for the TopKAT:

- Standalone electronic: one TopKAT up to eight electronic hoses
- Standalone mechanical: one TopKAT, one or two mechanical hoses
- Standalone or master/satellite controlling up to eight mechanical hoses (four hoses per PCU, up to two PCUs). This option is referred to as Mechanical PCU in this manual.
- Master/Satellite, all electronic: Up to eight electronic hoses; one TopKAT acts as the master and controls all hoses. It also allows up to seven satellite readers which can access all pumps.
- Master/Satellite, all mechanical, up to 16 hoses; (two hoses per TopKAT)
- Master Satellite, one 9820 or 9800 single or twin, electronic controlled by the master. Up to 14 mechanical hoses (two hoses per TopKAT) controlled by the satellites.

Abbreviations and Acronyms

Term	Description
&F	load a read-only factory configuration (a modem command to not be used)
&V	display current configuration (a modem command to not be used)
AC	Alternating Current
ARP	Address Resolution Protocol
ASC	Authorized Service Contractor
ASCII	American Standard Code for Information Interchange
ATR	go off hook (a modem command to not be used)
C	Celsius (as in 0°C)
CD	Carrier Detect
COMM	Communications
CPU	Central Processing Unit
CRC	Cyclical Redundancy Check (as in CRC1 or CRC2)
CRT	Cathode Ray Tube
DC	Direct Current
DD (or dd)	Day of month (01 - 31)
DIP	Dual Inline Package
E1	modem displays keyboard commands (a modem command to not be used)
EIA	Electronic Industries Alliance (formerly Electronic Industries Association)
EPROM	Erasable Programmable Read-Only Memory
F	Fahrenheit (as in 32°F)
HPG	Hours Per Gallon
HPL	Hours Per Liter
I/F	Interface
ID	Identification
IEEE	Institute of Electrical & Electronics Engineers
IP	Internet Protocol
K	Kilo or One Thousand (as in 64K, 128K, or 256K)
KM/L	Kilometers Per Liter

Term	Description
L/100KM	Liters Per 100 Kilometers
LAN	Local Area Network
LCD	Liquid Crystal Display
LED	Light Emitting Diode
LPH	Liters Per Hour
MAC	Machine Address Code (also known as Hardware or Ethernet address)
MM (or mm)	Month (01 - 12)
Modem	Modulator-Demodulator
MPG	Miles Per Gallon
N/A	Non Applicable
P/N	Part Number
PBX	Private Branch Exchange
PC	Personal Computer
PCB	Printed Circuit Board
PCMCIA	Peripheral Component Micro Channel Interconnect Architecture
PCU	Pump Control Unit
PIN	Personal Identification Number
POS	Point Of Sale
Q0	displays result codes (a modem command)
Q1	quiet mode, no result codes display (a modem command)
QTY	Quantity
RAM	Random Access Memory
RDY	Ready
ROM	Read-Only Memory
RS	Recommended Standard of IEEE (as in RS-232 or RS-422)
SNMP	Simple Network Management Protocol
SRAM	Static Random Access Memory
SW	Switch
T/Net	TopKAT Network
TCP	Transmission Control Protocol
TFTP	Trivial File Transfer Protocol
TP	Test Point (as in TP1, TP2, and so on)
TPI	Transport Service Programmers Interface
TTY	Teletypewriter
V	Version (as in V1.0, V1.1, or V2.0) Volt or Volts (as in 5V DC)
VEH	Vehicle
VPP (or Vpp)	programmable power supply
VR	Variable Resistor
WP	Write Protect
YY (or yy)	Year, last two digits (00 - 99)

Warranty

For information on warranty, refer to MDE-4255 Gasboy's Warranty Policy Statement. If you have any warranty-related questions, contact Gasboy's Warranty Department at its Greensboro location.

2 – Important Safety Information

This section introduces the hazards and safety precautions associated with installing, inspecting, maintaining or servicing this product. Before performing any task on this product, read this safety information and the applicable sections in this manual, where additional hazards and safety precautions for your task will be found. Fire, explosion, electrical shock or pressure release could occur and cause death or serious injury, if these safe service procedures are not followed.

Preliminary Precautions

You are working in a potentially dangerous environment of flammable fuels, vapors, and high voltage or pressures. Only trained or authorized individuals knowledgeable in the related procedures should install, inspect, maintain or service this equipment.

Emergency Total Electrical Shut-Off

The first and most important information you must know is how to stop all fuel flow to the pump/dispenser and island. Locate the switch or circuit breakers that shut off all power to all fueling equipment, dispensing devices, and Submerged Turbine Pumps (STPs).

WARNING



The EMERGENCY STOP, ALL STOP, and PUMP STOP buttons at the cashier's station WILL NOT shut off electrical power to the pump/dispenser. This means that even if you activate these stops, fuel may continue to flow uncontrolled.



You must use the TOTAL ELECTRICAL SHUT-OFF in the case of an emergency and not the console's ALL STOP and PUMP STOP or similar keys.

Total Electrical Shut-Off Before Access

Any procedure that requires access to electrical components or the electronics of the dispenser requires total electrical shut off of that unit. Understand the function and location of this switch or circuit breaker before inspecting, installing, maintaining, or servicing Gasboy equipment.

Evacuating, Barricading and Shutting Off

Any procedure that requires access to the pump/dispenser or STPs requires the following actions:



- An evacuation of all unauthorized persons and vehicles from the work area
- Use of safety tape, cones or barricades at the affected unit (s)
- A total electrical shut-off of the affected unit (s)

Read the Manual

Read, understand and follow this manual and any other labels or related materials supplied with this equipment. If you do not understand a procedure, call a Gasboy Authorized Service Contractor or call the Gasboy Service Center at 1-800-444-5529. It is imperative to your safety and the safety of others to understand the procedures before beginning work.

Follow the Regulations

Applicable information is available in National Fire Protection Association (NFPA) 30A; *Code for Motor Fuel Dispensing Facilities and Repair Garages*, NFPA 70; *National Electrical Code (NEC)*, Occupational Safety and Hazard Association (OSHA) regulations and federal, state, and local codes. All these regulations must be followed. Failure to install, inspect, maintain or service this equipment in accordance with these codes, regulations and standards may lead to legal citations with penalties or affect the safe use and operation of the equipment.

Replacement Parts

Use only genuine Gasboy replacement parts and retrofit kits on your pump/dispenser. Using parts other than genuine Gasboy replacement parts could create a safety hazard and violate local regulations.

Safety Symbols and Warning Words

This section provides important information about warning symbols and boxes.

Alert Symbol



This safety alert symbol is used in this manual and on warning labels to alert you to a precaution which must be followed to prevent potential personal safety hazards. Obey safety directives that follow this symbol to avoid possible injury or death.

Signal Words

These signal words used in this manual and on warning labels tell you the seriousness of particular safety hazards. The precautions below must be followed to prevent death, injury or damage to the equipment:



DANGER: Alerts you to a hazard or unsafe practice which will result in death or serious injury.



WARNING: Alerts you to a hazard or unsafe practice that could result in death or serious injury.



CAUTION with Alert symbol: Designates a hazard or unsafe practice which may result in minor injury.

CAUTION without Alert symbol: Designates a hazard or unsafe practice which may result in property or equipment damage

Working With Fuels and Electrical Energy

Prevent Explosions and Fires

Fuels and their vapors will explode or burn, if ignited. Spilled or leaking fuels cause vapors. Even filling customer tanks will cause potentially dangerous vapors in the vicinity of the dispenser or island.

Important Safety Information

No Open Fire



Open flames from matches, lighters, welding torches or other sources can ignite fuels and their vapors.

No Sparks - No Smoking



Sparks from starting vehicles, starting or using power tools, burning cigarettes, cigars or pipes can also ignite fuels and their vapors. Static electricity, including an electrostatic charge on your body, can cause a spark sufficient to ignite fuel vapors. Every time you get out of a vehicle, touch the metal of your vehicle, to discharge any electrostatic charge before you approach the dispenser island.

Working Alone

It is highly recommended that someone who is capable of rendering first aid be present during servicing. Familiarize yourself with Cardiopulmonary Resuscitation (CPR) methods, if you work with or around high voltages. This information is available from the American Red Cross. Always advise the station personnel about where you will be working, and caution them not to activate power while you are working on the equipment. Use the OSHA Lockout/ Tagout procedures. If you are not familiar with this requirement, refer to this information in the service manual and OSHA documentation.

Working With Electricity Safely

Ensure that you use safe and established practices in working with electrical devices. Poorly wired devices may cause a fire, explosion or electrical shock. Ensure that grounding connections are properly made. Take care that sealing devices and compounds are in place. Ensure that you do not pinch wires when replacing covers. Follow OSHA Lockout/ Tagout requirements. Station employees and service contractors need to understand and comply with this program completely to ensure safety while the equipment is down.

Hazardous Materials

Some materials present inside electronic enclosures may present a health hazard if not handled correctly. Ensure that you clean hands after handling equipment. Do not place any equipment in the mouth.

WARNING

The pump/dispenser contains a chemical known to the State of California to cause cancer.

WARNING

The pump/dispenser contains a chemical known to the State of California to cause birth defects or other reproductive harm.

In an Emergency

Inform Emergency Personnel

Compile the following information and inform emergency personnel:

- Location of accident (for example, address, front/back of building, and so on)
- Nature of accident (for example, possible heart attack, run over by car, burns, and so on)
- Age of victim (for example, baby, teenager, middle-age, elderly)
- Whether or not victim has received first aid (for example, stopped bleeding by pressure, and so on)
- Whether or not a victim has vomited (for example, if swallowed or inhaled something, and so on)

WARNING



Gasoline ingested may cause unconsciousness and burns to internal organs.

Do not induce vomiting.

Keep airway open.

Oxygen may be needed at scene.

Seek medical advice immediately.

WARNING



Gasoline inhaled may cause unconsciousness and burns to lips, mouth and lungs.

Keep airway open.

Seek medical advice immediately.

WARNING



Gasoline spilled in eyes may cause burns to eye tissue.

Irrigate eyes with water for approximately 15 minutes.

Seek medical advice immediately.

WARNING



Gasoline spilled on skin may cause burns.

Wash area thoroughly with clear water.



Seek medical advice immediately.

IMPORTANT: Oxygen may be needed at scene if gasoline has been ingested or inhaled. Seek medical advice immediately.

Lockout/Tagout

Lockout/Tagout covers servicing and maintenance of machines and equipment in which the unexpected energization or start-up of the machine(s) or equipment or release of stored energy could cause injury to employees or personnel. Lockout/Tagout applies to all mechanical, hydraulic, chemical or other energy, but does not cover electrical hazards. Subpart S of 29 CFR Part 1910 - Electrical Hazards, 29 CFR Part 1910.333 contains specific Lockout/ Tagout provision for electrical hazards.

Hazards and Actions

 WARNING	
	Spilled fuels, accidents involving pumps/dispensers, or uncontrolled fuel flow create a serious hazard.
	Fire or explosion may result, causing serious injury or death. Follow established emergency procedures.

The following actions are recommended regarding these hazards:

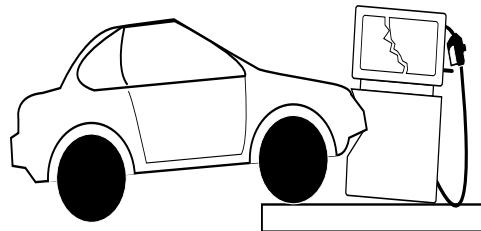

Collision of a Vehicle with Unit



Fire at Island

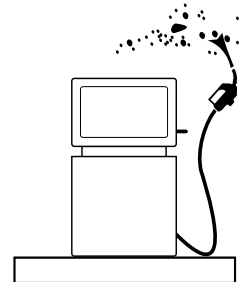

Fuel Spill

- Do not go near a fuel spill or allow anyone else in the area.
- Use station EMERGENCY CUTOFF immediately. Turn off all system circuit breakers to the island(s).
- Do not use console E-STOP, ALL STOP and PUMP STOP to shut off power. These keys do not remove AC power and do not always stop product flow.
- Take precautions to avoid igniting fuel. Do not allow starting of vehicles in the area. Do not allow open flames, smoking or power tools in the area.
- Do not expose yourself to hazardous conditions such as fire, spilled fuel or exposed wiring.
- Call emergency numbers.

This page is intentionally left blank.

3 – System Overview

Hardware Description

The TopKAT is totally self-contained in a rugged, well-designed, and attractive weatherized cabinet. The front bezel and rear of the cabinet are hinged doors secured with locks to prohibit unauthorized access. The front bezel allows access to the optional report printer and paper. When installing, be sure to provide adequate clearance to allow easy access to both front and rear doors for servicing.

The wiring for all equipment connected to the TopKAT is terminated in the head. A standalone TopKAT can control up to eight electronic hoses or two mechanical hoses. If you have the master/satellite option, you can control up to eight electronic hoses and seven satellite readers or up to 16 mechanical (two hoses per TopKAT), or one 9820 or 9800 single or twin electronic and up to 14 mechanical hoses (two hoses per TopKAT). A standalone or master/satellite with the mechanical PCU option can control up to eight mechanical hoses (four hoses per PCU, up to two PCUs). The system can handle quantity pulsing rates of 1000 pulses per unit of product.

The unit is equipped with a data key receptacle. Visual prompting messages, displayed on the two-line Liquid Crystal Display (LCD), guide the user through the steps required to activate the pump/remote dispenser, as well as configure the system. The display is backlit so that it can be read at night. A 16-position non-tactile keypad is provided on the face of the unit for entering data such as Personal Identification Number (PIN), odometer reading, pump selection, and so on. A beeper indicates when a key is pressed.

Power: AC power for the TopKAT comes from the same power connection used to power the 9800 Micro Feed. No customer connections are required between the 9800 and TopKAT. Connections to the 9820 are made as detailed in MDE-4319 TopKAT Fuel Management System Installation Manual.

Operating Environment: The unit has been designed to withstand an environment of -22°F to 122°F (-30°C to 50°C), 95% relative humidity, non-condensing.

Location: The TopKAT is located on the fueling island. Adequate clearance around the head of the unit is important to provide room for maintenance of the system. A minimum of 14 inches of clearance from the rear of the unit must be provided to allow the rear door to open.

CPU Printed Circuit Board

The Central Processing Unit (CPU) Printed Circuit Board (PCB) and its relevant components are shown in [Figure 3-1](#).

Figure 3-1: CPU PCB Components

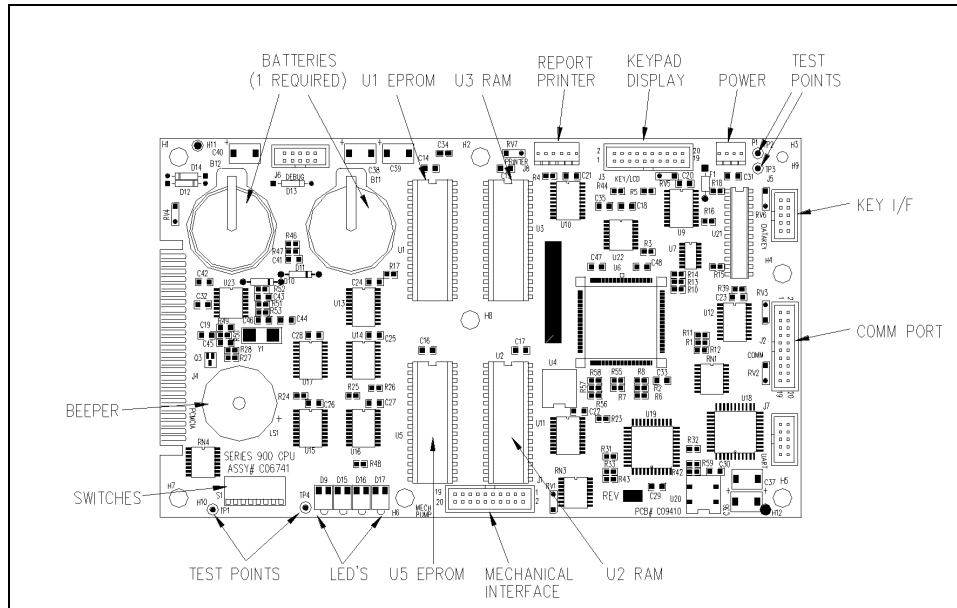

CPU PCB Switch Settings

CAUTION

All switch settings, except SW1-1 should be changed with the system power OFF.

- Switch settings SW1-3 through SW1-8 are read once by the CPU PCB directly after power is turned on.
- SW1-1 is read by the CPU periodically during normal operation.
- When setting switches, open=up; closed=down.

The CPU PCB switches should be set as follows:

Switch	Function	Setting
SW1-1	Manager Mode	Open
	Normal Operation	Closed
SW1-2	Not used	
SW1-3	Report Printer Enabled	Open
	Report Printer Disabled	Closed
SW1-4	Internal Modem Enabled	Open
	Internal Modem Disabled	Closed

Port 2 Baud Rate	SW1-5	SW1-6
300	Closed	Closed
1200	Closed	Open
2400	Open	Closed
9600	Open	Open

Port 3 Baud Rate	SW1-7	SW1-8
300	Closed	Closed
1200	Closed	Open
2400	Open	Closed
9600	Open	Open

CPU LEDs

The purpose of the CPU LEDs (left to right) is as follows:

LED	Color	Indicates
D9	Yellow	System Health: should flash approximately 2 times per second
D15	Green	Power On
D16	Amber	Battery Low
D17	Red	CPU PCB Reset Active

Battery Maintenance/Replacement

Check Battery Low LED periodically. If lit, replace the battery using the following procedure.

CAUTION

Do not turn off system power! This could cause irrevocable loss of data.

- 1 Insert a new battery, C09415, into the empty battery receptacle on the CPU PCB.
- 2 Remove the old battery from its battery receptacle. Battery Low (Amber) LED should go out.

Communications

Communications Ports

The TopKAT contains three asynchronous ports:

- Port 1 is used for communications to the 9800, mechanical PCU, and satellites via RS-485 lines.
- Ports 2 and 3 can be set for either RS-232 or RS-422 communications to a data terminal or computer. If used with the 9800, wiring restrictions dictate that only one of these two ports can be used for terminal/computer communication, unless Port 3 is connected to an internal modem. The 9820 ASTRA and the mechanical PCU option have no wiring restrictions.

MDE-4340/MDE-4341 Series 9800 Q/A Installation/Operation Manual, MDE-4319 TopKAT Installation Manual, MDE-4331 Atlas™ Fuel Systems Installation Manual, and MDE-4520 Enhanced Communications Installation Manual contain detailed communication requirements for port wiring and exceptions. Communication is through direct wire, by dial-up phone lines using an optional internal modem, by serial-to-LAN connection, or wireless communications.

Communications Protocol

Devices that communicate with the TopKAT must be able to transmit and receive full duplex, ASCII asynchronous data via an EIA RS-232 connection.

The TopKAT supports both a simple and a structured computer protocol. With the simple terminal protocol, no special characters are transmitted to designate the beginning or end of data blocks. Data is transmitted in serial bit format per character as follows: one start bit, eight data bits, one stop bit. Each character is echoed back to the transmitting device. This checks the integrity and enables the CRT operators to display transmitted data.

The structured computer protocol is covered in a separate manual, C35965 TopKAT Host Communications Manual.

Initiating Communications

You can communicate with the TopKAT by one of the following methods:

- Via the LCD menu system using SW1-1 Manager Mode switch
- Via the LCD menu system using the Manager's key
- Via terminal commands using a data terminal or PC

During initial power-up, you must use the Manager Mode switch which is located on the CPU Board. Setting DIP switch (SW1-1) to the Open position places the system in Manager mode and activates the LCD Menu System. The system displays COMMAND: SETUP.

You can access the LCD menu system using the Manager key any time after the System ID, Password, and Vehicle Record for the Manager Key are entered into the Database.

You can access the TopKAT command mode via a data terminal or PC for the first time by setting the Manager Mode switch (SW1-1) to OPEN and entering terminal commands (no password is required). Later, when the switch is in its normally closed position, you can access the commands by entering the correct password at the SIGN ON: prompt then entering terminal commands. This ensures system security.

Operating Modes

There are two modes of operation, direct printout mode and command mode. In direct printout mode, the TopKAT displays transactions and system events on the data terminal (or logger) as they occur.

Note: The Configure Logger command (CO LOG) must be set to enabled for this to occur.

In command mode, you enter terminal commands to input data, change data, or print reports on the system. When you are in command mode, transactions do not print as they occur, instead they are stored in memory and printed when the system returns to direct printout mode.

Note: When you sign on in command mode, the system automatically signs off after 5 minutes of keyboard inactivity and returns the system to direct printout mode.

9800 Switch Settings

The table below contains the proper switch /jumper settings for the 9800 CPU PCB for operation with the TopKAT. Refer to MDE-4334 Atlas™ Start-up/Service Manual for additional information on setting 9800 switches/jumpers.

Switch SW1/Jumper		Function	Setting
Old CPU	New CPU (M06333KXXXX)		
SW1-1	JP1	9600 Baud	Open
SW1-2	JP2	On-Line Mode	Open
SW1-3/SW1-4	JP3/JP4	Delay Time Setting	
		0 seconds	Closed/Closed
		4 seconds	Closed/Open
		5 seconds	Open/Closed
	6 seconds	Open/Open	
SW1-5	JP5	Not used	N/A
SW1-6	JP6	No Authorization	Open
SW1-7	JP7	Reset Totalizers	Closed
		Normal	Open

Switch SW1/Jumper		Function	Setting
Old CPU	New CPU (M06333KXXXX)		
SW1-8	JP8	RS-485 Pump Stop Detection Disabled	Closed
N/A	JP9	Not used	N/A

JP3 and JP4 set the delay time used by leak detectors in submersible pump applications. The delay time is the period between activation of the submersible pump and activation of the slow flow valve. Set this time according to the type of leak detector installed on the submersible pump to allow a normal leak test for each transaction. The delay time should be set to 0 seconds for suction pumps.

JP7 should be open for normal operation. When closed, this switch enables the reset of electronic totalizers.

JP8 is available only with 9800 software, version 5.3 or higher. Switch 1-8 is set to Closed to disable RS485 pump stop detection. This is necessary because the TopKAT operates in a half-duplex configuration and it is possible for the 98xx to detect a false break character when the half duplex lines switch from receive mode to transmit mode and vice-versa. These random false break characters will cause the 98xx to terminate the transaction.

SW2-1 through SW2-4 (Only on M06333KXXXX CPU)

Function	Setting
Address 1	All Closed

SW2-5 and SW2-6 - Unit of Measure Selection (Only on M06333KXXXX CPU)

These two switches set the unit of measure (US gallons, liters, or Imperial gallons) that the pump/dispenser will be using to meter fuel.

Unit of Measure	SW2-5	SW2-6
US Gallons	Closed	Closed
Liters	Open	Closed
Imperial Gallons	Closed	Open
NOT USED (default US Gallons)	Open	Open

SW2-7 - Electro-mechanical Totalizer Enable (Only on M06333KXXXX CPU)

This switch is only used on K model dispensers/pumps (excluding the 9850K model). When closed (“On”), it enables the pump/dispenser to drive electro-mechanical totalizers used on some K pump models. On A and Q models, this switch is ignored.

EM Totalizer	SW2-7
Enabled	Closed
Disabled	Open

SW2-8 - Background Debug Module (BDM) Enable (Only on M06333KXXXX CPU)

This switch must be OPEN for normal operation.

SW2-9 - Software Load Enable (Only on M06333KXXXX CPU)

This switch must be OPEN for normal operation. When this switch is closed, it enables loading the new M06333KXXXX CPU software.

SW2-10 (Only on M06333KXXXX CPU)

This switch is not used. Set to the Open position.

Report Printer Interface Option - Standalone or Master Only

A report printer interface is available as an option for the TopKAT. TopKAT is equipped with a report printer have a printer controller board and a print mechanism mounted in the lower right-hand side of the bezel. Printer output exits the base of the bezel through a weather-protection printer door. This door should remain closed except while printing reports. The system prompts you to open the printer door before printing reports. The report printer option is available only at a standalone or master TopKAT unit.

Accessing the Printer

To access the printer, insert the key into the key slot located at the right-hand side of the bezel. Turn it clockwise, then pull outward to open the bezel.

Printer Controller PCB

Figure 3-2: Printer Controller PCB Components

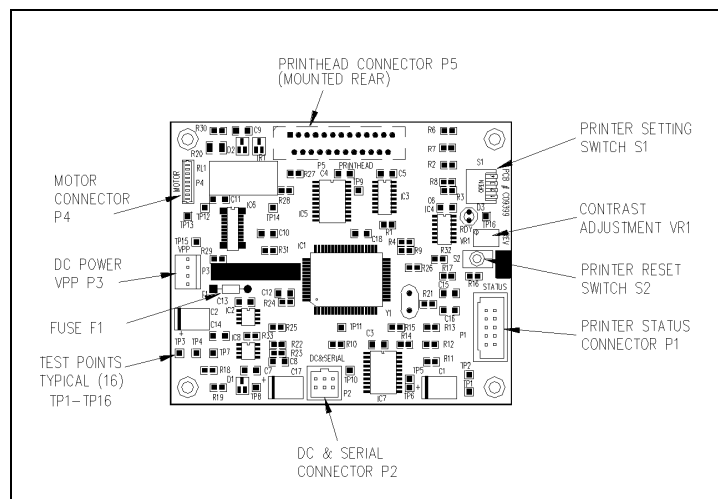

Setting Switches

Setting switches on the Printer Controller PCB can be done with the power ON. When the required switch settings are made, press **S2 Reset** on the Printer Controller PCB and the system will read the new settings. The RDY light on the Printer Controller PCB indicates that the printer is online and ready to print. If the printer does not print, press **Reset** and verify that the RDY light comes on.

Your switches should be set properly at the factory; however, you can verify their settings as follows:

Switch SW1	Function	Setting
SW1-1	Not used	N/A
SW1-2	Paper Thickness: 1-ply	Open (factory setting)
	Paper Thickness: 2-ply	Closed
SW1-3, SW1-4	Head Rank: A	Open, Open
	Head Rank: B	Open, Closed
	Head Rank: C	Closed, Open

SW1-3 and SW1-4 indicate print head resistance. The settings for SW1-3 and SW1-4 must correspond to the head rank (A, B, or C) indicated on the label on the top left of the printer mechanism.

Adjusting Contrast

If contrast adjustment is necessary, adjust VR1 on the Printer Controller PCB. It is set to mid range at the factory. Adjusting the print contrast to darker will slow the print speed; adjusting the print contrast lighter will increase the print speed.

Loading Paper

When printer paper is getting low, a pink band will appear on the edge of the paper. Replacement paper is available from Gasboy, P/N C01819. Follow these steps to replace the paper and see [Figure 3-3](#).

Figure 3-3: Printer - Side View

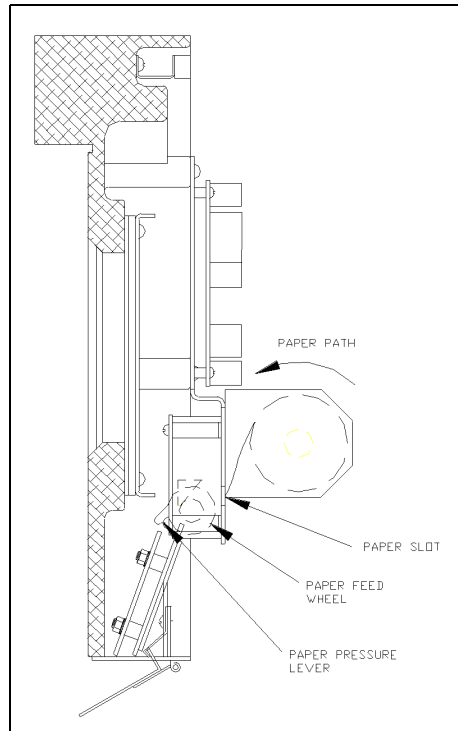

- 1 To access the printer, insert the key into the key slot located at the right-hand side of the bezel. Turn it clockwise, then pull outward to open the bezel.
- 2 Looking at the rear side of the bezel, locate the printer paper holder and printhead mechanism. At the right-hand side of the printhead, locate the printhead paper feed wheel.
- 3 Turn the paper feed wheel counterclockwise until the paper is removed.
Note: If the paper does not move when the paper feed wheel is rotated, the paper pressure lever is in the pressure release position. Rotate the lever toward you so that it points straight downward. This places the lever in the pressure engage position.
- 4 Using a flat-blade screwdriver, remove the screw and the small metal plate securing the left side of the paper holder. Remove the old paper roll.
- 5 Take the new paper roll and feed the paper into the paper slot. Turn the paper feed wheel clockwise until paper catches.
- 6 Install the paper roll on the spindle with the paper feeding counterclockwise, over the top of the roll and into the slot.

- 7 Reattach small metal plate and screw.
- 8 Press **S2 Reset** on the printer controller board to put the printer back online. The RDY light should go on.
- 9 Close bezel and lock turning the key counterclockwise and pressing the bezel inward until locked.

PCMCIA Interface Option - Standalone or Master Only

An optional Peripheral Component Micro Channel Interconnect Architecture (PCMCIA) interface allows a user to back up and restore all or part of the system's memory which includes the vehicle and employee file data, transactions, and system configuration.

The PCMCIA option consists of a PCMCIA interface board with a socket for insertion of a PCMCIA card. The PCMCIA socket/board is accessible through the back door of the cabinet. User prompts at the display guide the user through the backup or restore process.

The PCMCIA option is available only at a standalone or master TopKAT unit.

PCMCIA Interface PCB

Figure 3-4: PCMCIA Interface PCB Components

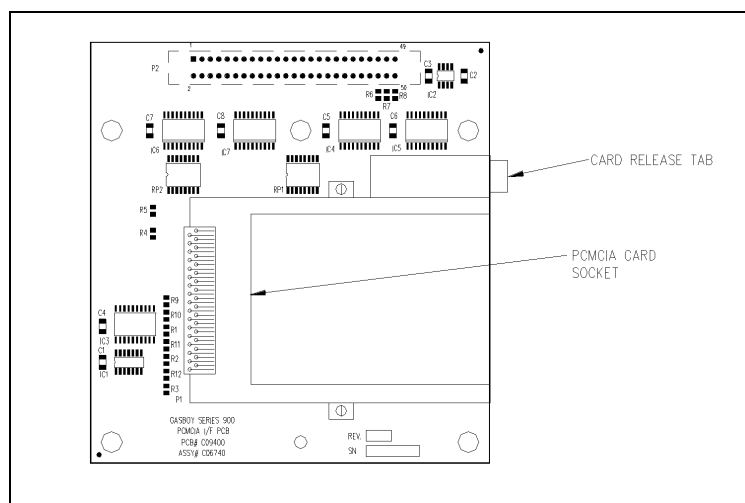

Master/Satellite (T/Net) Option

The master/satellite option (also called the T/Net option), allows you to network up to 8 TopKAT units together to control a maximum of 16 hoses (electronic and mechanical combination). If all your pumps are 9800 electronic pumps or you have mechanical PCUs, up to 8 hoses may be controlled. One TopKAT functions as the master unit, the remaining units function as satellites. A single database resides at the master consisting of system data, vehicle file data, manual entry file data, transaction, pump, and tank data.

The master TopKAT provides the satellite with the vehicle and (if configured) the manual entry records required to authorize a transaction. If your configuration is all 9800 electronics or uses mechanical PCUs, the TopKAT master controls all pumps. If you are using a combination of 9800 electronic and mechanical pumps, the master controls the electronic pump (one PCU, single or twin pump) and the satellite controls its local mechanical pump(s) and returns completed transaction data to the master upon completion of a sale. The master TopKAT then updates its database with transaction information.

The TopKAT with the master/satellite option is set up and configured slightly differently from a standalone TopKAT. The differences are as follows:

- Load Mode (refer to [“Setup Menu”](#) on [page 30](#))
This new prompt is present in all TopKAT units. When your TopKAT is a standalone unit, this prompt is set to standalone. When using the master/satellite option, the master unit is designated as Master. This prompt must be set to Satellite at each satellite unit.
- Poll Address (refer to [“Setup Menu”](#) on [page 30](#))
Functions the same as for standalone TopKAT units; however the master must be set as 01 and the satellites must be set as 01 through 07.
- Password (refer to [“Setup Menu”](#) on [page 30](#))
Can be loaded at master and at satellites.
- Config Trans File (refer to [“Transaction File Setup - Keypad”](#) on [page 55](#))
All functions available at master unit; only Clear Trans in Progress, available at satellite unit.
- Satellites controlling mechanical pumps are recognized as individual Pump Control Units (PCUs) and are configured at the TopKAT master, using the PCU SETUP keypad sequence (refer to [“Tank, Pump, and PCU File Setup - Keypad”](#) on [page 47](#)) and/or the CONFIGURE SYSTEM and CONFIGURE PCUS terminal commands (refer to [“Terminal Commands”](#) on [page 87](#)).
- Diagnostics are available at the keypad of both the master and satellite units; however, the system must be stopped or the satellite must be offline. Enhanced diagnostics from the terminal are effective only for the master unit.
- Certain options, such as PCMCIA backup and restore and report printing are available only at the master unit.

Mechanical Interface Option

The mechanical interface option (Mechanical I/F) allows the TopKAT to control and monitor up to two mechanical pumps. TopKATs equipped with the mechanical interface can also be used as part of a master/satellite configuration. Use of this interface results in additional hardware (Pump Control PCB and solid-state relays) and additional software parameters.

Hardware

The Pump Control PCB is mounted on the inside rear of the chassis; solid state relays which control power to the pump are located within the chassis. The Pump Control PCB controls all mechanical pumps by driving the relays which control the pump power, monitors status of the pump handle to turn relays off, monitors incoming pulses to count quantity, and contains status LEDs and manual override switches for each hose outlet. Wiring connections and switch settings for the Pump Control PCB are discussed in more detail in the Installation Manual.

Software

When a mechanical interface-equipped TopKAT is used as part of a master/satellite configuration, the TopKAT is configured using PCU assignments (refer to [“About the PCU File”](#) on page 52). When used in standalone mode (one TopKAT controlling two mechanical hoses), two parameters in the Pump File are used with the mechanical interface option: pump switch timer and pulse rate. The parameters are loaded via the keypad under LOAD PUMP TABLE in the Pump file or via the terminal using the L PU (LOAD PUMP) command.

Pump Switch Timer Parameter

The pump switch timer parameter prevents new fueling transactions at a pump when the handle has been left on from a previous transaction. In this case, when a new transaction is initiated, the pump cannot reset and, if pumping is allowed, the quantity shown at the pump includes the previous transaction quantity.

When the pump switch timer parameter is set, the handle is checked at the beginning of each transaction. If it is found to be on, the user will see the message TURN OFF PUMP HANDLE and the transaction will be terminated. A transaction is generated with the message PUMP SWITCH ERROR. The user must turn off the pump handle and begin a new transaction in order to fuel.

The pump switch timer parameter sets a time period during which the pump is checked. This time period must be less than the time that it takes for your pump to reset and transmit a switch detect signal back to the fuel management system. Nearly all pumps take more than one second to reset and transmit switch detect, so the values for this option range from .1 to 1 second, in tenths of a second, with .5 being a commonly used value. This value may need to be adjusted for your pumps. A setting of zero disables this option.

Pulse Rate Parameter

Set the pulse rate parameter with the appropriate pulse rate for your pump. The mechanical interface supports pulse rates of 1, 10, 100, 500, and 1000 in gallons; 1, 10, 100, and 250 in liters. If using a 9800 as a mechanical pump, pulsing should be set to 1000:1 for gallons; 250:1 for liters. If using bulk fueling, the pulse rates for gallons will be 1:1, 10:1 and 100:1 for gallons and those listed above for liters.

Transaction Changes

If you have the mechanical interface option, the transaction quantity decimal places are truncated to match the pulse rate (that is 10:1 pulse rate would display xxxxx.x; 100:1 pulse rate would display xxxxx.xx, and so on).

Mechanical PCU Option

The Mechanical Pump Control Unit (Mechanical PCU) option for the TopKAT allows the unit to control fueling and gather information from up to eight mechanical hose outlets (four per PCU, with a maximum of two PCUs). The TopKAT with Mechanical PCU is mounted on top of a pedestal. All PCUs can be mounted within the pedestal or wall-mounted. All pump/dispenser wiring connections are made within the TopKAT pedestal, when using internal PCUs or within the wall-mounted PCUs. The TopKAT with the Mechanical PCU option can also be used in a master/satellite configuration. Use of this interface results in additional hardware and software parameters.

Hardware

Each mechanical PCU includes two solid-state relays and one manual override switch per hose outlet which control power to the fuel dispensing equipment. The TopKAT can handle quantity pulsing rates as listed below in the Pulse Rate Parameter section. Wiring connections and switch settings for the Pump Control PCB are discussed in more detail in the Installation Manual.

Software

When used with the Mechanical PCU option in standalone mode or master/satellite (one TopKAT controlling up to eight hoses on two mechanical PCUs), two parameters in the Pump File are used: pump switch timer and pulse rate. The parameters are loaded via the keypad under LOAD PUMP TABLE in the Pump file or through the terminal using the L PU (LOAD PUMP) command.

Pump Switch Timer Parameter

The pump switch timer parameter prevents new fueling transactions at a pump when the handle has been left on from a previous transaction. In this case, when a new transaction is initiated, the pump cannot reset and, if pumping is allowed, the quantity shown at the pump includes the previous transaction quantity.

When the pump switch timer parameter is set, the handle is checked at the beginning of each transaction. If it is found to be on, the user will see the message TURN OFF PUMP HANDLE and the transaction will be terminated. A transaction is generated with the message PUMP SWITCH ERROR. The user must turn off the pump handle and begin a new transaction in order to fuel.

The pump switch timer parameter sets a time period during which the pump is checked. This time period must be less than the time that it takes for your pump to reset and transmit a switch detect signal back to the fuel management system. Nearly all pumps take more than one second to reset and transmit switch detect, so the values for this option range from .1 to 1 second, in tenths of a second, with .5 being a commonly used value. This value may need to be adjusted for your pumps. A setting of zero disables this option.

Pulse Rate Parameter

Set the pulse rate parameter with the appropriate pulse rate for your pump. The mechanical interface supports pulse rates of 1, 10, 100, 500, and 1000 in gallons; 1, 10, 100, and 250 in liters. If using a 9800 as a mechanical pump, pulsing should be set to 1000:1 for gallons; 250:1 for liters. If using bulk fueling, the pulse rates for gallons will be 1:1, 10:1 and 100:1 for gallons and those listed above for liters.

Transaction Changes

If you have the mechanical interface option, the transaction quantity decimal places are truncated to match the pulse rate (that is, 10:1 pulse rate would display xxxxx.x; 100:1 pulse rate would display xxxxx.xx, and so on).

Typical Fueling Sequence - Standalone or Master/Satellite

A typical fueling using a TopKAT vehicle key is accomplished as follows.

- 1 Position your vehicle adjacent to the fuel dispensing equipment. Be sure to note the odometer reading (if your system requires you to enter the odometer reading).
- 2 In its idle state, the TopKAT LCD displays one of the following three messages:
 - INSERT KEY
 - ENTER VEHICLE CODE
 - INSERT KEY OR ENTER VEHICLE CODE

Note: If system is stopped, OUT OF SERVICE displays on master and all satellites.

- 3 Insert the vehicle key into the key receptacle and turn it clockwise, or enter vehicle code* (if not using keys). *Vehicle code is key number.
Note: If your daily limit has been exceeded, the message DAILY LIMIT EXCEEDED displays and fueling is denied.
- 4 If your key requires an odometer entry, proceed to step 5. If your key requires a Manual Entry only, skip to step 6. If your key requires a PIN entry only, skip to step 7. If your key requires neither, skip to step 8.

- 5 If you are required to enter an odometer reading, the LCD displays: ENTER ODOMETER. Use the keypad to enter the mileage that appears on your vehicle's odometer (up to six digits, no tenths). The digits appear as they are entered. If you make a mistake, press **CLEAR** and enter the reading again. When you enter the correct reading, press **ENTER**. The system performs a reasonability check and if the reading is accepted, it writes the value to the key (into the last odometer field). If the entered odometer is not accepted, you can retry entry up to the number of times specified in the LOAD ODOMETER RETRIES command.
- 6 If your system requires a manual entry, the LCD displays the prompt for that field. Enter the data requested using the keypad. The digits appear as they are entered. If you make a mistake, press **CLEAR** and reenter the data. When you enter the correct data, press **ENTER**.
- 7 If you are required to enter a PIN, the LCD displays: ENTER PIN.

Using the keypad, enter your PIN number and press **ENTER**. To ensure security, an asterisk (*) appears for each digit that you press. If you make a mistake while entering your PIN, press **CLEAR** and enter it again.

You have three tries to enter the correct PIN. If you have a key system, after the third unsuccessful try, the display instructs you to TURN KEY LEFT, REMOVE. Turn and remove your key, then start again at step 3. If you have a non-key system, after the third unsuccessful try, the display returns to the configured idle message (step 2) and you must restart at step 3.

If your system uses the Auto Pin Lockout feature, the key is automatically locked out (invalidated) after the third unsuccessful PIN entry.

- 8 The LCD displays SELECT PUMP. Enter the required pump number and press **ENTER**. If you have only one pump, the system automatically selects it and does not prompt.

If the pump you selected cannot be accessed, one of the following messages appears:

- INVALID PUMP
- PUMP IN USE
- PUMP DISABLED
- INVALID FUEL

You have three tries to select a correct pump. If after three attempts, you have not chosen a correct pump, the display for a key system instructs you to TURN KEY LEFT, REMOVE. Turn and remove your key, then start again at step 3. For a non-key system, the display returns to the configured idle message (step 2) and you must restart at step 3.

If the pump is available and you are authorized to use it, the display will show:

PUMP #xx IS READY
TURN KEY LEFT, REMOVE.

Note: Non-key systems will display the top line message only. Skip to step 10.

- 9 Remove the key from the receptacle. If you leave the key in the receptacle for more than five seconds, an alarm sounds to remind you to remove it.

- 10 Proceed to dispense fuel. When you finish fueling your vehicle, turn off the dispenser handle and return the nozzle to its holder. The transaction information is automatically recorded in the system's memory for later recall. The transaction information may also be printed on the data terminal or logger.

Delivery or Dipstick Key Sequence

This is now available at Master and all on-line satellites. To enter into the Delivery or Dipstick Key Sequence, proceed as follows:

- 1 Observe the selected idle message.
Note: In its idle state, the TopKAT LCD displays the selected idle message.
- 2 After completion of the delivery or to record a dipstick reading, insert the delivery or dipstick key into the key receptacle and turn it clockwise.
The system responds ENTER TANK #.
- 3 Enter the appropriate tank number and press **ENTER**.
The system responds ENTER TANK QTY.
- 4 Enter the appropriate quantity and press **ENTER**.
The system responds QUAN. RECORDED TURN KEY LEFT, REMOVE.
- 5 Remove key.

Supervisor Key Sequence

To enter into the Supervisor Key Sequence, proceed as follows:

- 1 Observe the selected idle message.
Note: In its idle state, the TopKAT LCD displays the selected idle message.
- 2 Insert supervisor key into the key receptacle and turn it clockwise.
The system responds KEY #(0) or VEH # (1).
- 3 If you are entering a key number, press **0**. The KEY # prompt appears.

~ OR ~

If you are entering a vehicle number; press **1**. The VEH # prompt appears.
- 4 Enter the appropriate key or vehicle number and press **ENTER**.

At this point, the system follows its normal fueling sequence.

4 – Getting Started/System Setup

Setting Up the System

When you first set up the TopKAT system, you will have to perform setup functions to define your system attributes and vehicle file. There are several methods for this depending on your system configuration. Setup can be performed from the TopKAT keypad, via a data terminal and a set of terminal commands, the PCMCIA restore option, or through a Gasboy PC Software package.

The procedure for setting up the TopKAT varies. With the keypad, you must progress through a series of displayed commands and fill in the data for each. With the terminal, you can execute commands individually. If you have a Gasboy PC/TopKAT software package, a series of menus guides you through system configuration.

This section describes the steps required for setting up your system for the first time, and keypad system setup sequences. Section 10 describes setting up the system using commands at a data terminal. PC/TopKAT software is described in another manual, MDE-4490 PC/TopKAT User's Guide.

Navigating the Keypad

To access the keypad options, insert and turn the manager key. The PASSWORD prompt appears. Enter the appropriate password and the COMMAND: SETUP prompt appears.

Note: The password may be overridden by setting CPU PCB switch SW1-1 to Open. The COMMAND: SETUP prompt appears.

The keypad for the TopKAT consists of numeric keys 0-9 and the following keys:

ENTER transmits entered information to the TopKAT and allows you to select menu options. It is also used to acknowledge and clear error or status messages.

CLEAR clears the entry.

NO/ESC is used as a no response to a verification prompt or to move to the first option in a menu.

YES/PREV is used as a yes response to a verification prompt or to move back to the previous menu level from a submenu.

UP and **DOWN** arrow keys move from one menu item to the next.

During command actions, the system sometimes displays this symbol <. When you see this symbol at the end of a command display, you must press the **ENTER** key to acknowledge the action and return to the previous selection.

Setting Up Your System for the First Time

- Perform Setup commands to configure the system.
- Set up the files you will need for fuel management: vehicle file, manual entry file, tank file, pump file, PCU setup file, and the transaction file.

The start-up commands for your system may be executed through the system keypad, through the optional terminal interface, or via a PC/TopKAT software package. The commands essential for system operation are listed with the proper access path for keypad or terminal interface. PC/TopKAT software information is contained in a separate manual.

In addition you may use additional commands to customize your system to your personal preferences. These commands are detailed in the chapters that follow.

Keypad Setup for Standalone or Master Mode

To enter into the Keypad Setup for Standalone or Master Mode, proceed as follows:

- 1 Enter Setup mode; move CPU board switch SW1, position 1 to Open.
- 2 Stop the pumps.
Sequence: Setup/Stop
- 3 Load the system mode (STANDALONE or MASTER).
Sequence: Setup/Load Mode/selection
- 4 Load the type of PCUs from this list:
 - ALL 9800
 - 4-HOSE MECH. PCU(S)
 - 2-HOSE MECH I/F
 - 9800 + MECH (master only).Sequence: Setup/Load PCU Type/selection
- 5 Load the type of entry mode to be used from this list:
 - KEY ONLY
 - KEYPAD ONLY
 - KEY OR KEYPADSequence: Setup/Select Entry Mode/selection
- 6 Load the system date.
Sequence: Setup/Load Date
- 7 Determine if the validation of manually entered numbers will be required. You will complete defining your manual entry file in steps 9 and 10. If not using manual entry, go to step 8.
Sequence: Setup/Manual Entry Config
- 8 Clear the Vehicle File.
Sequence: Setup/Vehicle File/Clear File

- 9 Add the required vehicle records into the system file. Remember that keys purchased through Gasboy will be encoded as key #1 through key #50, and then as specified. Load vehicle records to correspond to existing key numbers.
Sequence: Setup/Vehicle File/Veh Rec Maintenance/Key#/Add Vehicle Record

Note: FOR KEYLESS: When using the vehicle code entry as the main identification method, most users want the entered code to represent their vehicle number. In the system, the vehicle code links to the key number in the vehicle file. Therefore, when you set up the vehicle file for keyless entry, set the key numbers to match the vehicle numbers. Consequently, when you are requested to enter your vehicle code, it will be the same as entering your vehicle number.

- 10 If you are using manual entries, clear the Manual Entry File. If not, skip to step 12.
Sequence: Setup/Manual Entry File/Clear File
- 11 Add the required manual entry records into the system file.
Sequence: Setup/Manual Entry File/Man Rec Maintenance/Add Man Ent Record
- 12 Load the number of tanks.
Sequence: Setup/Tank File/Load # of Tanks
- 13 Initialize the tanks to clear delivery information.
Sequence: Setup/Tank File/Initialize File
- 14 Load the tank table.
Sequence: Setup/Tank File/Load Tank Table
- 15 Load PCU assignments (With standalone TopKATs or master/satellite with multiple PCUs attached; for 9800 units attached to TopKAT; for master/satellite option, to identify mechanical master/satellite units). If you are identifying satellites in a master/satellite configuration, skip step 16.
Sequence: Setup/PCU Setup
- 16 Load the number of pumps.
Sequence: Setup/Pump File/Load # of Pumps
- 17 Initialize the pumps to clear the totalizers and the reset date.
Sequence: Setup/Pump File/Initialize File
- 18 Load the pump table.
Sequence: Setup/Pump File/Load Pump Table
- 19 Clear the transaction file.
Sequence: Setup/Config Trans File/Clear Trans File
- 20 Load the initial transaction number to 1.
Sequence: Setup/Config Trans File/Load Trans Number

- 21 For systems with the terminal option on port 2, determine whether the logger option should be enabled. It is disabled at the factory. When enabled, transactions will print to the terminal upon completion. To change the setting of this command:
Sequence: Setup/Config Trans File/Config Trans Logger
- 22 Determine whether Memory Protection is required. The system is shipped with the Memory Protection enabled, which means if transactions are not polled out of the system, the memory could fill up and stop accepting new transactions until polling is completed. Disabling Memory Protection means transactions may be overwritten as memory fills.
Sequence: Setup/Config Trans File/Memory Full Protect
- 23 Execute the RUN command to start communications between the dispensing equipment and the TopKAT. This command is valid at the master only when used in master/satellite combinations.
Sequence: Setup/Run
- 24 Exit Setup mode. Move CPU board switch SW1, position 1 to Closed.

Keypad Setup for Satellite Mode

To enter into the Keypad Setup for Satellite Mode, proceed as follows:

- 1 Enter Setup mode; move CPU board switch SW1, position 1 to Open.
- 2 Load the system mode (SATELLITE).
Sequence: Setup/Load Mode/selection
- 3 Load the type of entry mode to be used from this list:
 - KEY ONLY
 - KEYPAD ONLY
 - KEY OR KEYPADSequence: Setup/Select Entry Mode/selection
- 4 Load the Poll Address.
Sequence: Setup/Load Poll Address
- 5 Clear the transaction file.
Sequence: Setup/Config Trans File/Clear Trans File
- 6 Load the initial transaction number to 1.
Sequence: Setup/Config Trans File/Load Trans Number
- 7 For systems with the terminal option on port 2, determine whether the logger option should be enabled. It is disabled at the factory. When enabled, transactions will print to the terminal upon completion. To change the setting of this command:
Sequence: Setup/Config Trans File/Config Trans Logger
- 8 Determine whether Memory Protection is required. The system is shipped with the Memory Protection enabled, which means if transactions are not polled out of the system, the memory could fill up and stop accepting new transactions until polling is completed. Disabling Memory Protection means transactions may be overwritten as memory fills.
Sequence: Setup/Config Trans File/Memory Full Protect
- 9 Exit Setup mode. Move CPU board switch SW1, position 1 to Closed.

Terminal Mode Setup

To enter into the Terminal Mode Setup, proceed as follows:

- 1 Enter command mode. Press **ENTER** to bring up SIGN ON: message. The password is factory loaded to GASBOY.
- 2 Stop the pumps if running. Type **STOP**.
- 3 Load the current date. Type **LO DA**.
- 4 Define your manual entry field name. Type **CO MA**. Select the name.
- 5 Clear files using clear file command. Type **CL F** and select option 5 to clear all files.
- 6 Add records to your vehicle file and manual entry file. Use **AD REC V** for the vehicle file; use **AD REC x** for the manual entry file where x is the first character of the manual entry name.
Note: When loading vehicle records, remember that keys purchased through Gasboy will be encoded as key #1 through key #50, and then as specified. Load vehicle records to correspond to existing key numbers.
- 7 Configure system parameters. Use the **CO SY** and **CO PC** commands depending on your configuration. Refer to the details for each command in [“Terminal Commands”](#) on [page 87](#).
- 8 Initialize the pump and tank files. Type the initialize file command, **I F** and select option 3 to initialize the pump file and option 4 to initialize the tank file.
- 9 Load the pump and tank files. Type **L PU** and load the pump data, then type **L TA** and load the tank data.
- 10 Load the starting transaction number. Type **LO TR** and enter the number.
- 11 For systems with the terminal option on port 2, determine whether the logger option should be enabled. It is disabled at the factory. When enabled, transactions will print to the terminal upon completion. Type the configure logger (**CO LOG**) command.
- 12 Determine whether Memory Protection is required. The system is shipped with the Memory Protection enabled, which means if transactions are not polled out of the system, the memory could fill up and stop accepting new transactions until polling is completed. Disabling Memory Protection means transactions may be overwritten as memory fills. Type enable protection command (**EN PR**).
- 13 Execute the **RUN** command to start communications between the dispensing equipment and the TopKAT. Type **RUN**.

Accessing the Main Menu Options

To access the Main Menu Options, proceed as follows:

- 1 Insert and turn the Manager key.
- 2 Enter the password. The COMMAND: SETUP prompt displays.
- 3 Use the up and down arrow keys to scroll through the menu choices: SETUP, REPORTS, DIAGNOSTICS, and UTILITIES.

Setup Menu

Accessing the Setup Commands

To access the Setup Commands, proceed as follows:

- 1 Access the Main Menu. When COMMAND: SETUP appears, press **ENTER**.
- 2 Use the up and down arrow keys to scroll through the SETUP commands. Press **ENTER** when the required command is displayed.
- 3 Type any command input and press **ENTER** again.
- 4 Repeat steps 2 and 3 as needed. To exit from the SETUP commands, press **PREV** as many times as necessary.
- 5 Use the up and down arrow keys to scroll through the main menu choices.

STOP (only for Master and Standalone Modes)

Use STOP to stop the fuel site. All ongoing transactions are terminated and site is stopped until a RUN command is issued. This command is valid only from the master unit in master/satellite combinations. When the system is stopped, OUT OF SERVICE displays on the master and all satellite displays.

RUN (only for Master and Standalone Modes)

Use RUN to start (or re-start after a stop) the site. During initial system power-up, if all essential system operating data is not correct, the system will not start and will have to be started with the RUN command after the fault conditions are corrected. This command is valid only from the master unit in master/satellite combinations.

LOAD MODE

Use LOAD MODE to select the operating mode for the TopKAT. Available choices are STANDALONE, MASTER, or SATELLITE. This option must be set individually at the master and at each satellite. When the mode is changed, you are prompted to confirm the change.

LOAD PCU TYPE (only for Master and Standalone Modes)

Use LOAD PCU TYPE to load the configuration for the types of pumps you are using. Available choices for standalone and master are: ALL 9800, 4-HOSE MECH PCU(S), 2-HOSE MECH. I/F. An additional choice appears on the master: 9800 + MECH.

SELECT ENTRY MODE

Use SELECT ENTRY MODE to indicate the ways the system will be accessed. Available choices are: KEY ONLY, KEYPAD ONLY, KEY OR KEYPAD. This option must be set individually at the master and at each satellite.

LOAD DATE (only for Master and Standalone Modes)

Use LOAD DATE to load the current date. The TopKAT should be factory-loaded with the correct date, but occasionally, you may need to change it.

LOAD TIME (only for Master and Standalone Modes)

Use LOAD TIME to load the current time on 24-hour format (00:00 to 23:59). The TopKAT is factory-loaded to Eastern time with the correct time, but occasionally, you may need to change it.

LOAD SITE NO (only for Master and Standalone Modes)

Use LOAD SITE NO to load the four-digit site number. This number appears at the beginning of each transaction listing and as the first four digits when you print compacted transactions.

LOAD POLL ADDRESS

Use LOAD POLL ADDRESS to load a two-digit address to be used for computer mode communication with the TopKAT. For standalone, master and first satellite, this address should be loaded to 1. If setting up a satellite, the poll address must be between 1 and 7. The poll address becomes the assigned satellite number.

This entry also contains a subprompt that will enable you to default your terminal mode password to GASBOY.

LOAD SYSTEM ID (only for Master and Standalone Modes)

Use LOAD SYSTEM ID to load the four-digit system ID. This number is unique to your system, assigned at the factory, and is encoded onto your access keys. It guards against users of other systems accessing your system.

LOAD PASSWORD

Use LOAD PASSWORD to load the manager key password. The password you enter when using the manager key at the keypad is limited to four digits. It is factory-loaded as 1234. The password you use when entering commands through a data terminal is limited to 10 alphanumeric characters. When using the master/satellite option, the password can be loaded at the master and the satellites.

LOAD REAS RANGE (only for Master and Standalone Modes)

Use LOAD REAS RANGE to load a four-digit value for the maximum number of miles/hours that may be traveled between fuelings for an odometer to be considered reasonable. If this field is loaded as 0, the system does not use a maximum miles traveled range when it validates the odometers, but it does expect the odometer entered to exceed any previous odometer entry.

LOAD ODOM RETRIES (only for Master and Standalone Modes)

Use LOAD ODOM RETRIES to load up to 2 digits for the number of times the odometer will be re-prompted for when an incorrect odometer has been entered.

Note: When both LOAD REAS RANGE and LOAD ODOM RETRIES are set to 0, the system will not perform a reasonable odometer check for any odometer entered. During a fueling, when an odometer entry is detected, any entered odometer is accepted. If the entered odometer is less than the previous odometer entry, fueling is allowed and an ODOM RANGE ERROR is logged.

INVALID PIN LOCKOUT (only for Master and Standalone Modes)

Use INVALID PIN LOCKOUT to indicate whether the system should lock out a vehicle record when an invalid PIN is entered. This is a YES or NO value. If this value is set to yes, the vehicle record is locked out after the number of PIN tries (3) has been exceeded. If this value is set to no, the system will not lock out the record if 3 invalid PIN tries are received.

SELECT FIELD NAME (only for Master and Standalone Modes)

Use SELECT FIELD NAME to select either DEPT or ACCT as the field name which is input into the vehicle file and printed on reports. If you do not select this prompt, DEPT is the default value.

MANUAL ENTRY CONFIG (only for Master and Standalone Modes)

Use MANUAL ENTRY CONFIG and its corresponding subentries to indicate how manual entry is handled (refer to “[CO nfigure MAnnual \(CO MA\)](#)” on [page 91](#) for more information).

At Manual Entry Name, select the name to be used for your manual entry field. Available names are:

EMPLOYEE #	JOB #
ACCOUNT #	AUXILIARY #
TRIP #	DRIVER #
MISC #	

At MANUAL ENTRY CHECK, indicate required or not required.

- If manual entry check is required, a record must exist in the manual entry file. The entry made by the user at the keypad must match a field in the manual entry record.
- If manual entry check is not required, the user can enter anything at the manual entry field and it will be accepted.

MEASUREMENT UNITS (only for Master and Standalone Modes)

This command allows you to indicate, for reporting and transactions, the type/format of units of measure.

- DISTANCE provides 3 options: MILES, KILOMETERS, HOURS.
- QUANTITY provides 3 options: GALLONS, LITERS, LITRES.
- DATE FORMAT provides 3 options: MM/DD/YY, YY/MM/DD, DD/MM/YY.
- RATE allows you to indicate how you want your fuel efficiency monitored: MPG=miles per gallon; HPG=hours per gallon; L/100KM=liters per 100 kilometers; LPH=liters per hour; KM/L=kilometers per liter; HPL=hours per liter.

Note: When you select hours, instead of miles, kilometers, or liters, no system prompts are changed. The system will still request ENTER ODOMETER. However, in reports (Print System or Department/Vehicle) or print transactions, units will appear as hours.

- PUMP TIMEOUT MODE allows one of two time-out modes to be selected: USA or INTERNATIONAL. USA allows for a maximum of 180 seconds, as required by Weights and Measures. INTERNATIONAL allows for a maximum of 255 seconds.

BULK FUELING (only for Master and Standalone Modes)

This command allows you to indicate whether bulk fueling operations will be active at this site. Select **YES** or **NO** accordingly.

Note: The PCU Type must be set to four-hose mechanical or two-hose mechanical to use bulk fueling. If bulk fueling is set to Yes, All 9800 and 9800 + Mech cannot be selected as PCU types.

This page is intentionally left blank.

5 – Vehicle File Setup - Keypad

About the Vehicle File

The vehicle file is where all vehicle information is defined. The vehicle file options are presented in the order they appear on the menu; however, the first thing you will do is add vehicle records.

All vehicle records must have a unique key number and vehicle/department number combination. The vehicle/department number is combined by the system for sorting purposes. You can access vehicle records by key number or by the vehicle/department number. Up to 2000 vehicle records may be stored.

In addition to each vehicle in your fleet, you must also provide a vehicle record for any special keys you wish to encode (supervisor, manager, report, dipstick, or delivery). As with all vehicle records, each special key record must have a unique key number and vehicle/department combination, but you can just press **ENTER** through the remaining vehicle file fields.

The vehicle file format is as follows:

Key No	5 digits (typically set to match vehicle number in keyless applications)
Vehicle No	5 digits
Dept or Acct*	4 digits
Limit	1 digit
Authorization	1 digit
Check Digit	1 digit
Lockout Status	1 digit
PIN #	4 digits
Beginning Odometer	6 digits
Last Odometer	6 digits
Total Quantity	8 digits (xxxxx.xxx)
Max Fuelings/Day	2 digits
# Fuelings Today	2 digits
# Fuelings to Date	3 digits - totalizer reset when file is initialized.
<i>*As determined by Select Name prompt in Setup.</i>	

Limitation Codes

Product limitation codes are one-digit codes that are used to restrict the maximum quantity of product dispensed per transaction.

Product limitation is provided mainly as a safeguard to minimize accidental spillage. The appropriate limitation code is loaded in the Limit field of the vehicle file. The value assigned should be the nearest quantity greater than the vehicle's tank size. If the user dispenses fuel to the quantity limit of his key, the transaction automatically terminates. If the user wants additional product, he can initiate another transaction and dispense additional product up to the limit cutoff.

The table below shows the pre-assigned limitation codes available for use. When using bulk fueling, use the table columns to the right regardless of whether bulk measurement is in gallons.

Gallons		Liter or Bulk	
Limit Code	Limit Cutoff Quantity	Limit Code	Limit Cutoff Quantity
0	5	0	20
1	15	1	60
2	20	2	80
3	25	3	100
4	2	4	8
5	50	5	200
6	100	6	400
7	200	7	800
8	300	8	1200
9	999	9	9999

Authorization Codes

Authorization code is a one-digit numeric field (0 - 9) used to specify the type of fuels one may access. You can load one of these code types into the Authorization field of the vehicle file. The user is permitted to access only the product types represented by that code. Code 0 allows access to all fuels.

Up to 4 product codes (1 - 4) are supported. You decide which product code is associated with each fuel type (that is, 1=unleaded, 2=super unleaded, 3=diesel, 4=kerosene).

The table below shows the pre-assigned authorization codes available for use.

Auth Code	Product Codes Allowed
0	All Products
1	Product 1
2	Product 2
3	Product 3
4	Product 4
5	Product 1, 2
6	Product 1, 3
7	Product 2, 3
8	Product 1, 2, 3
9	Product 1, 3, 4

Check Digit

Check digit is a one-digit numeric field used to determine what data must be entered at the keypad. The table below shows the available codes.

Code	Required Manual Keypad Entries
0	No entries required
1	Odometer entry required
2	Manual entry required
3	Odometer and manual entry required
4	Vehicle PIN required*
5	Odometer and vehicle PIN required*
6	Manual entry and vehicle PIN required*
7	Odometer, manual entry, and vehicle PIN required*

*See "PIN" on [page 38](#) for explanation of vehicle PIN.

Lockout

Lockout can be against the vehicle file (by Key # or Vehicle/dept combination) or the manual entry file (by the manual entry field).

When a key is used for fueling, the system accesses the vehicle record and checks the lockout status field.

- If it is set to LOCKED OUT, the transaction is denied.
- If it is ACTIVE, the transaction proceeds as follows.
The check digit is read and if a manual entry is required [and if manual entry check (SETUP: MANUAL ENTRY CHECK) is set to REQUIRED], the manual entry file is accessed.
 - If the lockout status field in the manual entry file is set to LOCKED OUT, the transaction is denied.
 - If the lockout status field in the manual entry file is set to ACTIVE, the transaction proceeds and the system prompts for the next entry.

PIN

PIN entry is required and validated against the manual entry PIN field if all of the following conditions are met:

- manual entry is required by the vehicle record
- the system parameter MANUAL ENTRY CHECK is set to required
- the manual entry record PIN field is not 0000

PIN entry is required and validated against the vehicle record PIN if all the conditions under any of the following scenarios are met:

Scenario 1: Vehicle PIN required and manual entry not required by vehicle record.

Scenario 2: Vehicle PIN required, manual entry required by vehicle record, and system parameter MANUAL ENTRY CHECK is set to NOT REQUIRED.

Scenario 3: Vehicle PIN required, manual entry required by vehicle record, system parameter MANUAL ENTRY CHECK is set to REQUIRED, manual entry record PIN field is 0000.

Vehicle Record Maintenance

To perform Vehicle Record Maintenance, proceed as follows:

- 1 Insert and turn the Manager key.
- 2 Enter the password. The COMMAND: SETUP prompt displays. Press **ENTER**.
- 3 Press either arrow key until VEHICLE FILE appears. Press **ENTER**.
- 4 At VEH REC MAINTENANCE, press **ENTER**.
- 5 At SEARCH BY, indicate how you want the vehicle file to be sorted. Use the arrow keys to display one of two available options: SEARCH BY KEY # or SEARCH BY VEH/DEPT # or VEH/ACCT # and press **ENTER**. The EDIT/VIEW VEHICLE prompt appears.

Edit/View Record

To edit or view the Record, proceed as follows:

- 1 At EDIT/VIEW VEHICLE, press **ENTER**. Depending on the method by which you elected to sort the file, the following prompts appear. If you selected KEY #, the KEY # prompt and first key record in the file appears. If you selected VEH/DEPT # or VEH/ACCT #, the VEHICLE # prompt and the first vehicle record in the file appears.
- 2 Type a number at the keypad or use the arrow keys to scroll through the key or veh/dept and veh/acct numbers using arrow keys until you reach the one you wish to edit/view and press **ENTER**.
- 3 Use the arrow keys to display the vehicle record fields. If you wish to view the field, press **ENTER** when the field name appears. Then press **ENTER** to return to the vehicle record files. If you wish to edit the field, press **ENTER**, type a new value and press **ENTER** again. Then resume using the arrow keys to view the rest of the fields.

Add Vehicle Record

To add Vehicle Record, proceed as follows:

- 1 At EDIT/VIEW VEHICLE, press the arrow key until ADD VEHICLE RECORD appears and press **ENTER**.
The KEY # prompt appears.
- 2 Enter the appropriate information for key, vehicle and department or account, pressing **ENTER** after each entry.

Note: The remainder of the vehicle record fields are set to zero and will remain so unless you change them. If you do not wish to enter data into a field, press the down arrow key at that field and the next prompt will display.

- 3 At LIMIT, press **ENTER**, type a limitation code (0 - 9) and press **ENTER**.
The LIMIT prompt reappears; use the down arrow key to proceed.
- 4 At AUTHORIZATION, press **ENTER**, type an authorization code (0 - 9) and press **ENTER**.
The AUTHORIZATION prompt reappears; use the down arrow key to proceed.
- 5 At CHECK DIGIT, press **ENTER**, type a one-digit check digit code (0 - 7) and press **ENTER**. The CHECK DIGIT prompt reappears; use the down arrow key to proceed.
- 6 At LOCKOUT STATUS, press **ENTER**. Use the up and down arrow keys to toggle between ACTIVE and LOCKED OUT. When the appropriate choice is displayed, press **ENTER**. Use the down arrow to proceed.
- 7 At PIN, press **ENTER**, type a four-digit PIN and press **ENTER**.
The PIN prompt reappears; use the down arrow key to proceed.
- 8 At BEGINNING ODOMETER, press **ENTER**, then enter the odometer (six-digits; no tenths) for the vehicle (if required) and press **ENTER**.
The BEGINNING ODOMETER prompt reappears; use the down arrow key to proceed.
- 9 At LAST ODOMETER, press **ENTER**, then enter the current vehicle odometer (six-digits; no tenths), and press **ENTER**. Use the down arrow to proceed.
Note: Setting the odometer values to zero instructs the TopKAT to initialize the record using the odometer received the first time the key is used.
- 10 At TOTAL QUANTITY, press **ENTER**. This field accumulates the quantity of all fueling transactions for that vehicle record. This field is reset to zero when the vehicle file is initialized. This allows you to monitor fuel usage for a given period, typically weekly, monthly, or yearly based on how often you initialize the vehicle field. Enter 8 digits (xxxxx.xxx). The decimal point is fixed, so enter the appropriate number of zeros to form the correct number and press **ENTER**. Use the down arrow to proceed.
- 11 At MAX FUELINGS PER DAY, press **ENTER**. Type a two-digit number up to 15 for the maximum amount of times one vehicle can fuel in a 24-hour period and press **ENTER**. Zero allows unlimited fuelings. Use the down arrow to proceed.
- 12 At # FUELINGS TODAY, enter nothing. This field is updated in the vehicle file each time a user completes a fueling transaction. This value is reset each night between 00:00 and 00:05, depending on which time the key receptacle is idle (no key in receptacle). If no opportunity exists for this value to reset, another 24-hour period will elapse before the system retries the reset. Use the down arrow to proceed.
- 13 At # FUELINGS TO DATE, enter nothing. This field is updated from the beginning of the system start-up or vehicle file initialization.

Delete Vehicle Record

Allows you to delete a vehicle record by whichever field you elected to sort the vehicle file. If you sorted by key, the KEY prompt appears; if you sorted by vehicle/dept or vehicle/acct, the vehicle number prompt appears, followed by the department or account prompt. The TopKAT then asks you to verify your deletion by pressing the YES or NO key. Then, the record is deleted.

Encode Key

Allows you to encode a key from vehicle file data. This option is available under the Edit/View Vehicle Record and is activated by using the Manager Mode switch.

If encoding a key other than a vehicle key, remember that each key (supervisor, manager, report, dipstick, or delivery) must have a corresponding vehicle record. As with all vehicle records, each special key record must have a unique key number and vehicle/department combination, but you can just press **ENTER** through the remaining vehicle file fields.

Note: Do not activate the Manager mode switch (SW1) while in the vehicle file. This will lock the record and inhibit further access.

- 1 Activate the Manager Mode by turning switch SW1 to open. The COMMAND: SETUP prompt displays. Press **ENTER**.
- 2 Press either arrow key until VEHICLE FILE appears. Press **ENTER**.
- 3 At VEH REC MAINTENANCE, press **ENTER**.
- 4 At SEARCH BY, indicate how you want the vehicle file to be sorted. Use the arrow keys to display one of two available options: SEARCH BY KEY # or SEARCH BY VEH/DEPT # (or VEH/ACCT) and press **ENTER**. The EDIT/VIEW VEHICLE prompt appears. Press **ENTER**.
- 5 If you selected KEY #, the KEY # prompt and first key record in the file appears. Type a number at the keypad or use the arrow keys to scroll through the key numbers until you reach the one you wish to encode and press **ENTER**.

If you selected VEH/DEPT # (or VEH/ACCT #), the VEHICLE # prompt and the first vehicle record in the file appears. Use the arrow keys to scroll through the vehicle numbers. When you reach the correct vehicle number, press **ENTER**. The DEPARTMENT or ACCOUNT prompt appears. Use the arrow keys to scroll through the department/account records. When you reach the one you wish to encode, press **ENTER**.

- 6 Use the arrow keys to display the vehicle record fields. If you wish to change a field, press **ENTER** at the field name, type a new value and press **ENTER** again. Then resume using the arrow keys to view the rest of the fields. The last option will be ENCODE KEY.
- 7 To encode the key using the data in that vehicle record, press **ENTER**. The system responds SELECT KEY TYPE: VEHICLE. Use the arrow keys to select an alternate key type. Choices are vehicle, supervisor, manager, report, dipstick, or delivery. Press **ENTER** when the proper key type is displayed. The system responds INSERT KEY TO ENCODE.
- 8 Insert the key in the receptacle and turn. The key is encoded and the system displays FINISHED, REMOVE KEY TURN KEY LEFT, REMOVE.
- 9 Ensure that you take the system out of manager mode by returning switch SW1 to the closed position.

Initialize File

Use INITIALIZE FILE only at initial startup or if doing periodic reconciliations. Be sure to print any required reports before running INITIALIZE FILE, otherwise you will end up with reports containing initialized values.

This command copies the last odometer to the beginning odometer, clears all cumulative quantity totalizers, resets the # of fuelings to date, and resets the initialization date to the current date for the file.

Clear File

Use CLEAR FILE to clear all records from the vehicle file. This command erases any vehicle records previously stored in the vehicle file; they cannot be retrieved unless you have the PCMCIA backup option with a current backup of your vehicle file or a Gasboy PC/900 computer program with a current backup of your vehicle file. Important: On initial startup, be sure to run this command before entering any vehicle records.

6 – Manual Entry File Setup - Keypad

About the Manual Entry File

The manual entry file is used when you include a check digit in the vehicle record requesting a manual entry. Your manual entry field name is identified when you perform system SETUP (refer to “[Getting Started/System Setup](#)” on [page 25](#)).

Your system can be configured to check or not check manual entry (refer to “[MANUAL ENTRY CONFIG \(only for Master and Standalone Modes\)](#)” on [page 32](#) and “[CONfigure MAnual \(CO MA\)](#)” on [page 91](#)). If manual entry check is required, a record must exist in the manual entry file. The entry made by the user at the keypad must match a record in the manual entry file. If manual entry check is not required, the user can enter anything at the manual entry field and it will be accepted.

Your manual entry file contains all pertinent manual entry information in the following format:

Field	Format
Manual entry field	4 digits
Department*	4 digits
Total fuel	8 digits
# of fuelings	3 digits
Lockout Status	1 digit
PIN	4 digits

**This field remains as Department regardless of what you select in the SELECT NAME setup prompt.*

The manual entry file can contain up to 4000 manual entry records. Like the vehicle file, the manual entry file also contains a PIN field. Refer to “[PIN](#)” on [page 38](#) for details on how the PIN function operates.

Manual Entry File Maintenance

Accessing the Manual Entry File

To access the Manual Entry File, proceed as follows:

- 1 Insert and turn the Manager key.
- 2 Enter the password. The COMMAND: SETUP prompt displays. Press **ENTER**.
- 3 Press the arrow key until MANUAL ENTRY FILE appears. Press **ENTER**.
- 4 At MAN REC MAINTENANCE, press **ENTER**.
The EDIT/VIEW MAN ENT prompt appears.

Edit/View Manual Entry

To edit or view Manual Entry, proceed as follows:

- 1 At EDIT/VIEW MAN ENT, press **ENTER**. Type a number at the keypad or use arrow keys to scroll through the manual entry numbers until you reach the one you wish to edit/view and press **ENTER**.
- 2 Use the arrow keys to display the manual entry record fields. If you wish to view the field, press **ENTER** when the field name appears. Press **ENTER** again when finished. If you wish to change the field, press **ENTER**, type a new value and press **ENTER** again. Then resume using the arrow keys to view the rest of the fields.

Add Manual Entry Record

To add Manual Entry Record, proceed as follows:

- 1 At EDIT/VIEW MAN ENT, press the arrow key until ADD MAN ENT RECORD appears and press **ENTER**.
- 2 Enter the appropriate information for your manual entry field and press **ENTER**.
- 3 At Dept. #, enter the four-digit department and press **ENTER**. Use the down arrow to proceed.
- 4 At LOCKOUT STATUS, press **ENTER**. Use the up and down arrow keys to toggle between ACTIVE and LOCKED OUT. When the appropriate choice is displayed, press **ENTER**. Use the down arrow to proceed.
- 5 At PIN (if used), press **ENTER**, type a four-digit PIN and press **ENTER**.
The PIN prompt reappears; use the down arrow key to proceed.

- 6 At TOTAL QUANTITY, press **ENTER**. Enter eight digits (xxxxx.xxx) and press **ENTER**. The decimal point is fixed, so enter the appropriate number of zeros to form the correct number. Use the down arrow to proceed.
- 7 At # FUELINGS TO DATE, enter nothing. This field is updated from the beginning of the system start-up or manual entry file initialization.

Delete Manual Entry Record

Allows you to delete a manual entry record. Select DELETE MANUAL ENTRY. The manual entry name prompt appears. Type the manual entry number and press **ENTER**. The TopKAT then asks you to verify your deletion by pressing the YES or NO key. If YES is selected, the record is deleted.

Initialize File

Use INITIALIZE FILE only at initial startup or if doing periodic reconciliations. Be sure to print any required reports before running INITIALIZE FILE, otherwise you will end up with reports containing initialized values.

This command clears all cumulative quantity totalizers, resets the # of fuelings, and resets the initialization date to the current date for the file.

Clear File

Use CLEAR FILE to clear all records from the manual entry file. This command erases any manual entry records previously stored in the file; they cannot be retrieved unless you have the PCMCIA backup option with a current backup of your manual entry file or a Gasboy PC/900 computer program with a current backup of your manual entry file.

This page is intentionally left blank.

7 – Tank, Pump, and PCU File Setup - Keypad

About the Tank File

The TopKAT maintains inventory for your tanks. When you start up your TopKAT, you load the product code for the tank and the starting inventory.

When you get deliveries of fuel, you use the Add to Inventory command to add the amount to the existing inventory. You can also use the Subtract from Inventory command to subtract inventory from a tank. You might need to do this to keep inventory amounts accurate (such as if the TopKAT was down and fuel was being accessed manually).

If you have a key encoded as a delivery key, your supplier can enter delivery amounts right at the TopKAT as soon as the delivery is complete. This automatically increments your tank inventory and generates a transaction noted DELIVERY.

At any time, you can print an inventory report which lists the latest amount and date. Refer to [“Inventory Report”](#) on [page 67](#) for more information.

The tank inventory file contains the following:

Tank Number	1 digit
Product Number	1 digit
Quantity	10 digits (xxxxxxx.xxx)
Last Delivery Amount	8 digits (xxxxx.xxx)
Last Delivery Date	xx/xx/xx

Access the Tank File

To access the Tank File, proceed as follows:

- 1 Insert and turn the Manager key.
- 2 Enter the password. The COMMAND: SETUP prompt displays. Press **ENTER**.
- 3 Press the arrow key until TANK FILE appears. Press **ENTER**.

Load # of Tanks

At LOAD # OF TANKS, indicate how many tanks are being accessed by your pumps. Valid values are 1 through 9.

- 1 Access the Tank File. At LOAD # OF TANKS, press **ENTER**.
- 2 Enter a number (1 - 9) and press **ENTER**. Use the arrow keys to proceed.

Initialize File

Use INITIALIZE FILE only at initial startup. Be sure to print any required reports before running INITIALIZE FILE, otherwise you will end up with reports containing initialized data.

Load Tank Table

Use LOAD TANK TABLE to indicate the product contained in the tank and the current inventory. Use the product codes defined earlier (refer to “[Authorization Codes](#)” on [page 37](#)).

- 1 Access the Tank File. Press the arrow keys until LOAD TANK TABLE appears. Press **ENTER**.
- 2 Use the arrow keys to scroll to the tank number you want and press **ENTER**.
The Tank #x, PRODUCT CODE prompt appears.
- 3 Press **ENTER**. Then enter the product code (1 - 4) and press **ENTER**. Press the down arrow key. The Tank # x, QUANTITY prompt appears.
- 4 Press **ENTER**. Type a quantity value. Enter up to 10 digits (xxxxxxx.xxx) and press **ENTER**.
The decimal point is fixed.
- 5 Press **PREV** once, and repeat this from Step 2 to load another tank; otherwise, press **PREV** until the LOAD TANK TABLE prompt reappears.

Add to Inventory

Use ADD TO INVENTORY to record the amount of fuel added to a specific tank. Use this command to record deliveries when a delivery key is not used.

- 1 Access the Tank File. Press the arrow keys until ADD TO INVENTORY appears. Press **ENTER**.
- 2 To enter inventory for tank 1, press **ENTER**; otherwise press the down arrow key until the required tank appears, then press **ENTER**.
- 3 At TANK #x AMOUNT, type 8 digits. The decimal point is fixed, so enter the appropriate number of zeros to form the correct number. Press **ENTER**.
The DELIVERY? [YES] [NO] prompt appears.
- 4 If the addition is a delivery, press **YES**; if it is an inventory adjustment, press **NO**.
The ADD TO INVENTORY prompt reappears.

Subtract from Inventory

Use SUBTRACT FROM INVENTORY to subtract an amount of fuel from your tank. You may need to do this to keep inventory amounts accurate (such as if the TopKAT was down and fuel was being accessed manually).

- 1 Access the Tank File. Press the arrow keys until SUBTRACT FROM INVTY appears. Press **ENTER**.
- 2 To subtract inventory from tank 1, press **ENTER**; otherwise press the down arrow key until the required tank appears, then press **ENTER**.
- 3 At TANK #x AMOUNT, enter eight digits. The decimal point is fixed, so enter the appropriate number of zeros to form the correct number. Press **ENTER**.
The SUBTRACT FROM INVTY prompt reappears.

About the Pump File

Use the Pump file to define your pump's characteristics. The pump file is arranged in the following format:

pump number	2 digits
totalizer	10 digits (xxxxxxx.xxx)
product number	1 digit
tank number	1 digit
totalizer reset date	xx/xx/xx

Access the Pump File

To access the Pump File, proceed as follows:

- 1 Insert and turn the Manager key.
- 2 Enter the password. The COMMAND: SETUP prompt displays. Press **ENTER**.
- 3 Press the arrow key until PUMP FILE appears. Press **ENTER**. Pumps are stopped. If a transaction is in progress, access to the pump file is denied. Pumps are restarted when the pump file is exited.

Initialize File

Use INITIALIZE FILE only at initial startup. This command resets initialization date and pump totalizer. Be sure to print any required reports before running INITIALIZE FILE, otherwise you will end up with reports containing initialized values. When you have the master/satellite option, both master and satellite pump files are initialized.

- 1 At INITIALIZE FILE, press **ENTER**.
The system responds INIT PUMP FILE? Press [YES] or [NO].
- 2 Press appropriate response key. Press arrow keys to proceed.

Load # of Pumps (Standalone TopKAT, Master Electronic, Master Mechanical PCU)

Use this to load the number of pumps in your configuration (1 through 8).

- 1 Access the Pump File. At LOAD # OF PUMPS, press **ENTER**.
- 2 Type the number (1 through 8) and press **ENTER**. Use the down arrow key to proceed.

Load Base Pump (Standalone TopKAT and Master Electronic, Master Mechanical PCU)

Use LOAD BASE PUMP to enter a starting pump number (from 1 - 99) depending on how you wish your pumps to be numbered.

- 1 Access the Pump File. Press the arrow keys until LOAD BASE PUMP appears. Press **ENTER**.
- 2 Indicate the base pump number (01 - 99) and press **ENTER**. Use the down arrow to proceed.

Load Pump Table

Use LOAD PUMP TABLE to load specific information about a pump.

- 1 Access the Pump File. Press the arrow keys until LOAD PUMP TABLE appears. Press **ENTER**. If your TopKAT is standalone, the system displays PUMP #xx, TK:x,EN. If you have the master/satellite option, the prompt displays the pump numbers in numeric pump (master/satellite) pairs: PUMP #xx(y), TK:x,EN. (y) is set to M (master) for electronic or mechanical PCU options. If you use the mechanical I/F option or have combination electronic and mechanical, (y) is set to M or the satellite number.

Consider the following example:

PUMP #01(1), TK:1,ENPump 1(satellite 1), tank 1, enabled.
PUMP #02(M), TK:1,ENPump 2(master), tank 1, enabled.
PUMP #03(2), TK:2,ENPump 3(satellite 2), tank 2, enabled.
PUMP #04(2), TK:2,ENPump 4(satellite 2), tank 2, enabled.

- 2 Use the arrow key to display the required pump and press **ENTER**.
- 3 At TANK ASSIGNMENT, press **ENTER**. Type the tank number assigned to the pump. Tank numbers can be 1 - 9. Press **ENTER**. Use the down arrow key to proceed.
- 4 At TOTALIZER, press **ENTER**, then enter the totalizer reading from the pump. Enter up to 10 digits (xxxxxxx.xxx). The decimal point is fixed, so enter the appropriate number of zeros to form the correct number. Press **ENTER**. This number is incremented as fueling transactions occur. Use the down arrow key to proceed.
- 5 At TOTALIZER RESET DATE, press **ENTER**. The system displays TOT RESET: MMDDYY. Type the date the totalizer is reset and press **ENTER**. Use the down arrow key to proceed. Skip to step 8 unless you have a standalone TopKAT with mechanical pumps.

- 6 Press the arrow key until PULSE RATE is displayed, then press **ENTER**. Use the arrow keys to scroll through the available pulse rates (refer to “[Mechanical Interface Option](#)” on [page 20](#) or “[Mechanical PCU Option](#)” on [page 21](#) for information on this parameter). When the appropriate rate displays, press **ENTER**. Use the down arrow key to proceed.
- 7 At PUMP SWITCH TIMER, press **ENTER**. Use the keypad to enter a value from .1 to 1.0 (refer to “[Mechanical Interface Option](#)” on [page 20](#) or “[Mechanical PCU Option](#)” on [page 21](#) for information on this parameter) and press **ENTER**. Use the down arrow key to proceed until the ENABLE PUMP prompt appears.
- 8 The next prompt is ENABLE PUMP. To do this, press **ENTER**. If the pump is already enabled, the system displays ERROR: ALREADY ENABLED. Press **ENTER**, then press the down arrow.
- 9 At PUMP DISABLED, press **ENTER** if you wish to do this. The system displays DISABLED <. Press **ENTER**. To load another pump, press **PREV** and repeat from step 2. To return to the Pump file menu, press **PREV** twice.

Load Pump Timeouts

Use LOAD PUMP TIMEOUTS to load a value indicating the allowable interval between the time the pump is activated by the system and fueling begins and between releasing the nozzle (fueling ends) and turning off the pump handle.

Time-out periods range from 1 to 180 seconds for US and 1 to 255 seconds for international applications. A typical time-out is 80 seconds. If either time-out is exceeded during a transaction, the transaction ends automatically and a TIMED OUT message appears in the transaction error field.

- 1 Access the Pump File. Press the arrow keys until LOAD PUMP TIMEOUTS appears. Press **ENTER**.
- 2 Type a value from 1 - 255 and press **ENTER**. The system returns to LOAD PUMP TIMEOUTS. Press **PREV** to return to Pump File menu.

About the PCU File

The PCU file contains information on the physical setup of your electronic and master/satellite pumps. The TopKAT can control a total of eight PCUs (or two four-hose mechanical PCUs).

- When you use electronic pumps (9800 or ASTRA), the electronic pump is the PCU (up to eight electronic hoses can be controlled by a single TopKAT).
- When you use the mechanical I/F, the TopKAT serves as the PCU controlling one or two mechanical hoses; a master TopKAT can control up to 7 additional satellite TopKATs.

On a 9800 (viewed from the electronic totalizer switch side), the physical left-hand side of the pump is side 1 or slot 1; the physical right-hand side of the pump is side 2 or slot 2. On a 9820 ASTRA, since there is only one hose, it is always slot 1. The PCU file options allow you to change slot assignments to vary which side of the pump activates when a pump number is selected. There can be four slots per PCU for mechanical PCUs.

Because there are six different TopKAT configurations (refer to “[Introduction](#)” on [page 1](#) for a description of each), the PCU setup differs. Use the applicable PCU Assignments section for your configuration.

Access PCU Setup

To access PCU Setup, proceed as follows:

- 1 Insert and turn Manager key.
- 2 Enter password (if required). The COMMAND: SETUP prompt displays. Press **ENTER**.
- 3 Press the arrow key until PCU SETUP appears. Press **ENTER**.
- 4 Pumps are stopped. If a transaction is in progress, access to the pump file is denied. Pumps are restarted when the pump file is exited.

PCU Setup/PCU Assignments (Standalone, All Electronic; Master, All Electronic; Mechanical PCUs)

To enter into the PCU Setup or PCU Assignments, proceed as follows:

- 1 At PCU SETUP: press **ENTER**. TopKAT displays Stopping Pumps. At PCU SETUP: PCU ASSIGNMENTS, press the down arrow.
- 2 At LOAD # OF PCUs, press **ENTER**. Load the number of PCUs in your configuration and press **ENTER**. Press the down arrow. If your system is standalone, skip to step 4 (step 3 is not applicable).
- 3 At LOAD # OF SATELLITES, press **ENTER**. Load the number of satellites (if applicable) and press **ENTER**. Press the down arrow again to return to PCU SETUP: PCU ASSIGNMENTS.
- 4 To enter PCU ASSIGNMENTS, press **ENTER**. The system displays the current slots assigned to each pump starting with the lowest pump number. For example:
 PCU ASSIGNMENTS
 PUMP#01 PCU: 1 SLOT: 1

Press the down arrow to display other pumps.

- 5 To change assignments, press **ENTER**. The prompt PCU # appears. Press **ENTER**. Type the required PCU number (1 - 8) and press **ENTER**.
- 6 Press the down arrow to display PCU SLOT.
- 7 To change assignments, press **ENTER**. The prompt PCU SLOT appears. Type the required slot number and press **ENTER**.
- 8 Press **PREV** until PCU SETUP appears.
Note: If your configuration is Standalone Mechanical I/F, PCU Setup is disabled and your pump setup is done through the pump file.

PCU Assignments/Edit PCUs (Master Mechanical I/F, Master Combination)

Configure Master Unit for Mechanical Pumps

To configure Master Unit for Mechanical Pumps, proceed as follows:

- 1 At PCU SETUP: LOAD # SATELLITES, press **ENTER**.
- 2 Type the number of satellite units (1 - 7) and press **ENTER**. Use the down arrow to proceed.
- 3 At EDIT PCUS, press **ENTER**.
- 4 At EDIT PCUS: MASTER, press **ENTER**. Define the characteristics of your master unit.
 - At LOAD # of PUMPS, press **ENTER**. Type the number of pumps attached to the master (1 or 2) and press **ENTER**. Use the down arrow key to proceed.
 - At LOAD BASE PUMP, press **ENTER**. Indicate the base pump number (01 - 99) and press **ENTER**. Use the down arrow to proceed.
 - At MECH PUMP SETUP, press **ENTER**. The system displays the current pump numbers. Press **ENTER** at the required pump number. Use the down arrow to proceed.
 - At PULSE RATE, press **ENTER**. Use the down arrow until the required pulse rate displays and press **ENTER**. Use the down arrow to proceed.
 - At PUMP SWITCH TIMER, press **ENTER**. Type a value from .1 to 1.0 and press **ENTER** (refer to “[Mechanical Interface Option](#)” on [page 20](#) for details on this parameter).
 - Press **PREV** until EDIT PCUS: MASTER displays.
- 5 Press the down arrow until EDIT PCUS: SATELLITES displays. Press **ENTER**. Continue with the procedure “[Configure Satellite PCUs for Mechanical I/F Pumps](#)” on [page 54](#).

Configure Master Unit for Electronic Pump

To configure Master Unit for Electronic Pump, proceed as follows:

- 1 At PCU SETUP: LOAD # SATELLITES, press **ENTER**.
- 2 Type the number of satellite units (1 - 7) and press **ENTER**. Use the down arrow to proceed.
- 3 At EDIT PCUS, press **ENTER**.
- 4 At EDIT PCUS: MASTER, press **ENTER**. Define the characteristics of your master unit.
 - At LOAD # of PUMPS, press **ENTER**. Type the number of pumps attached to the master (1 - 8) and press **ENTER**. Use the down arrow key to proceed.
 - At LOAD BASE PUMP, press **ENTER**. Indicate the base pump number (01 - 99) and press **ENTER**. Use the down arrow to proceed.
 - At PCU ASSIGNMENTS, press **ENTER**. The system displays the current slots assigned to each pump starting with the lowest pump number. Use the down arrow to display other pumps.
 - At PUMP #nn SLOT, press **ENTER**. The prompt PCU SLOT appears. Type the required slot number and press **ENTER**.
 - Press **PREV** until EDIT PCUS: MASTER displays.
- 5 Press the down arrow until EDIT PCUS: SATELLITES displays. Press **ENTER**. Continue with the procedure [“Configure Satellite PCUs for Mechanical I/F Pumps”](#) on page 54.

Configure Satellite PCUs for Mechanical I/F Pumps

At EDIT SATELLITE PCU: SATELLITE #1, press **ENTER** to display the characteristics for the first satellite. If another satellite is required, press the arrow keys until the required number displays. Then press **ENTER**.

- At LOAD # of PUMPS, press **ENTER**. Type the number of pumps attached to the satellite (1 or 2) and press **ENTER**. Use the down arrow key to proceed.
- At LOAD BASE PUMP, press **ENTER**. Indicate the base pump number (01 - 99) and press **ENTER**. Use the down arrow to proceed.
- At MECH PUMP SETUP, press **ENTER**. The system displays the current pump numbers. Press **ENTER** at the required pump number. Use the down arrow to proceed.
- At PULSE RATE, press **ENTER**. Use the down arrow until the required pulse rate displays and press **ENTER**. Use the down arrow to proceed.
- At PUMP SWITCH TIMER, press **ENTER**. Type a value from .1 to 1.0 and press **ENTER** (refer to [“Mechanical Interface Option”](#) on page 20 for details on this parameter).
- Press **PREV** until EDIT SATELLITE PCU: SATELLITE #x displays. If configured for more than one satellite, repeat the satellite procedure to set up the remaining satellite units.

8 – Transaction File Setup - Keypad

About the Transaction File

Transactions provide a record of the activity at your fuel site. Fuel transactions are stored in memory and can be printed as they occur (direct printout) if a logger is present and enabled (CO LOG). Transactions can be polled from the TopKAT if you have a data terminal, built-in modem, or external modem. A Gasboy PC/TopKAT software package is also available to assist in transaction polling.

Transactions are stored in the following format:

Size (Digits)	Name
4	Transaction number
5	Vehicle key number
5	Vehicle number
4	Vehicle department (or account) number*
4	Manual entry number
4	Manual entry department number
6	Date (mmdyy)
4	Time (hh:mm)
2	Pump number
1	Product number
1	Tank number
8	Transaction quantity (xxxxx.xxx)
6	Vehicle cumulative quantity (xxxxx.x)
6	Manual entry cumulative quantity (xxxxx.x)
6	Odometer
4	Transaction miles
2	Error code

**As determined by Select Name prompt in Setup.*

Config Trans File

Move Trans Pointer

The TopKAT transaction file uses a circular memory storage technique that keeps accessible the last several hundred (at least 1650) transactions. There are two pointers in the transaction file: a safe pointer and a next transaction pointer.

- The safe pointer marks the beginning of the file location. The safe pointer remains fixed unless you move it using the Move Trans Pointer command.
- The next transaction pointer marks the next transaction to be assigned location. The next transaction pointer moves ahead each time a new transaction is received.

When you do a Print Transactions terminal command, your transaction printout begins at the safe pointer and ends with the last transaction before the next transaction pointer.

When the next transaction pointer reaches the safe pointer, and memory-full protection is enabled, the MEMORY FULL message displays and no more transactions can be stored or created. If memory-full protection is disabled, the safe pointer bumps up one transaction slot at a time as each new transaction is received thus overwriting existing transactions in memory.

To ease a memory-full condition, you can use the Move Trans Pointer command to move the safe pointer forward towards the next transaction pointer thus freeing up transaction storage space for new transactions. Before doing this, you need to poll your transactions. You can poll using the print transactions PR TR command. Transactions are read from the safe pointer to the next transaction pointer. Then use the MO PO command to relocate the pointer and make room for additional transactions. You can also poll using a Gasboy PC package. Transactions are copied to a file on the PC and the safe pointer is automatically moved to the next transaction pointer to free up memory for more transaction storage.

The locations of the transaction file pointers are shown in the System Configuration report. The following locations are shown: Oldest=oldest transaction still in memory; Safe=beginning of the file location; Last=last transaction in memory; Next=next transaction to be assigned.

Load Trans Number

Use Load Trans Number to load the starting or next transaction number. When you first start up your system, this number is usually set to 0001 so the first transaction number will be 0001; however, it can be set to any number you wish.

Clear Trans in Prog

Use Clear Trans in Prog to clear any transactions in progress in the event of communications problems between the TopKAT and the 9800 or satellites (when used). This command should be used with care as transactions may be lost. Contact Gasboy Technical Service before attempting this command. This command can be used at the master and satellite units.

Clear Trans File

Use Clear Trans File to clear all transactions from memory and reset the transaction pointer and the safe pointer to the physical beginning of the file. This command is typically used only at startup.

Record Error Trans

Set Record Error Trans to a YES or NO value.

- YES means that error transactions will be saved in memory.
- NO means that error transactions will not be saved in memory.

Note: Retaining error transactions may be useful in diagnosing system/key problems; however, if transaction space is at a premium, you may elect not to save error transactions.

Config Trans Logger

Set Config Trans Logger to an ENABLED or DISABLED value depending on whether you want to use direct printout mode or not.

Note: If you have a logger (printer) connected to record transactions, be sure to set this value to ENABLED.

Memory Full Protection

The Memory Full Protection feature is set to YES or NO.

- When set to YES, and transaction memory becomes full, the system will not accept further transactions and will display a MEMORY FULL message.
- When set to NO, and transaction memory becomes full, the system will start overwriting transactions, as new transactions occur. This can result in loss of transactions. Refer to [“Move Trans Pointer”](#) on [page 56](#) for ways to ease memory-full conditions.

This page is intentionally left blank.

9 – Modem Initialization - Keypad

About Modem Initialization

The Modem feature allows you to input one or two strings of modem commands up to 39 characters each (the 39-character limitation is a modem requirement). When the system is reset these default modem strings are loaded:

String 1	AT&D2V1E0S0=1&C1B1
String 2	AT&WQ1

There are two ways to access the modem feature, from a terminal command or from the keypad setup menu.

- Modem strings are entered using the LOAD MODEM (LO MOD) terminal command and they can be printed using the PRINT MODEM (PR MOD) command or initialized using the INITIALIZE MODEM (I MOD) command (refer to “[Terminal Commands](#)” on [page 87](#)).
- Keypad menu options allow you to print the modem strings and issue the initialize modem command to send the strings to the modem.

Keypad menu options are located on the SETUP Menu. MODEM appears after CONFIG TRANS FILE and before STOP. When you select MODEM, there are two menu choices:

- [PRINT MODEM INIT](#)
- [INIT MODEM](#)

Note: If the modem is not enabled, these selections come up as not available.

PRINT MODEM INIT

When you select PRINT MODEM INIT, you are prompted to view string 1 or string 2. This choice can also be done as the terminal command PRINT MODEM.

- 1 At the COMMAND: SETUP prompt, press the arrow key until MODEM appears. Press **ENTER**.
- 2 At PRINT MODEM INIT, press **ENTER**. The system prompts: STRING 1.
 - To display string 1, press **ENTER**.
 - To display string 2, press the down arrow and press **ENTER**.
- 3 To return to the SETUP prompt, press **PREV** until the SETUP prompt appears.

INIT MODEM

When you select INIT MODEM, the modem strings that were input using the LOAD MODEM terminal command are sent to the modem and a result response displays on line two of the display.

- 1 At the COMMAND: SETUP prompt, press the arrow key until MODEM appears. Press **ENTER**.
- 2 Press the arrow keys until INIT MODEM appears. Press **ENTER**.
The system displays ...please wait and then one of the following result codes:

Result	Description
SUCCESSFUL	No command errors and Q1 is present in string 2
STRING 1 FAILED	Incorrect modem command was detected
STRING 2 FAILED	Incorrect modem command was detected
NO RESPONSE	Modem not present or not functioning; or Q1 is in string 1
STRINGS OK, NO Q1	Modem commands are correct but Q1 is not present in string 2

There are three commands that should not be sent to the modem because the results will be unpredictable:

ATR	go off hook
E1	enable command echo (This is the default, however E0 is sent in the default initialization string to the TopKAT. Do not change the TopKAT string to E1)
&V	display current configuration

10 – Serial-to-LAN Configuration

Usage of the Serial-to-LAN Server should be transparent to the TopKAT operation. The Serial-to-LAN Server configuration is set up per the instructions in MDE-4520 Enhanced Communications Installation Manual.

This page is intentionally left blank.

11 – Wireless Communications Configuration

The primary reason to use wireless communications between TopKAT and the POS system is to avoid the need of digging a trench and installing metal conduit for communication wires. The wireless communications is accomplished by using a modem and antenna at each end (Figure 11-1). The distance between the TopKAT and POS system can be up to 3 miles (4.8 kilometers). There is no observable difference in the way TopKAT operates whether the communications is provided through communication wires or through a wireless system.

The wireless communications option is NOT intended to provide, nor can it extend communications between the following devices:

- Island Card Readers
- 9800 Series pumps/dispensers
- Gasboy PCUs
- other manufacturers' electronic pumps
- credit card network communications

Figure 11-1: TopKAT Wireless System - Directional Antenna at Each End

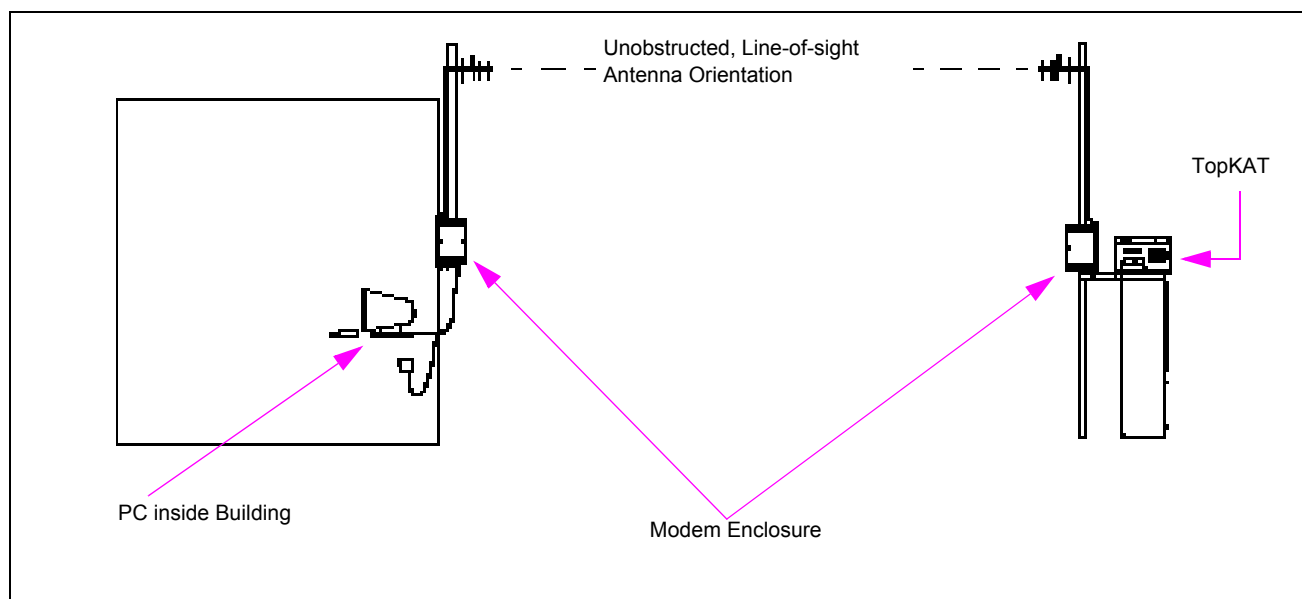

For more information on TopKAT Wireless Communications Installation, refer to MDE-4520 Enhanced Communications Installation Manual.

This page is intentionally left blank.

12 – Reports

About Reports

The TopKAT provides the following reports:

- Print Date/Time
- Print System Configuration (PRINT SYS CONFIG)
- Dept/Vehicle Rpt (DEPT/VEHICLE RPT or ACCT/VEHICLE RPT)
- Inventory Report
- Pump Report
- Vehicle File Report (VEH FILE REPORT)
- Vehicle Lockout Report (VEH LOCKOUT REPORT)
- Manual Entry Lockout Report (MAN LOCKOUT REPORT)
- Department Manual Entry Report (DEPT MAN ENT RPT)
- Manual Entry Report
- Events Report

Printing Reports

To print reports directly at the TopKAT, you must have the optional report printer installed.

Accessing the Report Menu

You can access the report menu by using the report key or the manager key or Manager mode switch.

- 1 If using the Manager key, insert and turn it. If using the Manager Mode switch, skip to step 3. If using the Report key, insert and turn it and skip to step 4.
- 2 Enter password (if required). The COMMAND: SETUP prompt displays.
- 3 Use the up or down arrow keys until REPORTS displays and press **ENTER**.
- 4 The system displays Please Open Printer Door and then the first entry on the report menu. Use the up or down arrow keys until the required report type displays and press **ENTER**. The report prints and the system displays REPORT SENT<. Press **ENTER** to continue.
- 5 Use the arrow keys to select the next report to print and press **ENTER**. You can queue up to 10 reports to print sequentially; you don't have to wait until each report is done printing to start the next one.

Print Date/Time

This report prints the current system date and time.

Print System Configuration (PRINT SYS CONFIG)

This report prints the values loaded for the following system parameters:

- Date
- Program version and program date
- Site number
- System ID
- Number of satellites (master/satellite option only)
- Satellite communication status (master/satellite option only)
- Poll address
- Pump time-out
- Reasonableness range
- Odometer retries
- Invalid PIN lockout
- Manual entry check
- Manual entry name
- Measurement units
- Key receptacle status
- Key read totalizer
- Transaction pointer locations (Oldest=oldest transaction still in memory; Safe=beginning of the file location; Last=last transaction in memory; Next=next transaction to be assigned)

Department/Vehicle Report (DEPT/VEHICLE RPT) or Account Vehicle Report (ACCT/VEHICLE RPT)

This report prints a date range (file initialization date to current) and the following Vehicle file values in department (or account) order:

- Vehicle number
- Last odometer
- Miles
- Quantity
- MPG
- Department (or account) totals and grand totals for quantity, miles, and average MPG.

Note: When computing grand totals for miles and average MPG, the TopKAT does not include vehicles that do not enter odometers or whose miles value is zero.

Inventory Report

This report lists the following information by tank:

- Date
- Tank number
- Product code
- Quantity
- Last delivery
- Delivery date

Pump Report

This report lists the following by pump:

- Date
- Pump number (followed by master/satellite number, if configured)
- Tank number
- Product code
- Totalizer
- Reset date
- Pulse rate (mechanical interface or mechanical PCU options only)
- Pump switch timer (mechanical interface or mechanical PCU options only)
- Pump status

Vehicle File Report (VEH FILE REPORT)

When selecting this report, you can select whether to print using Key or Veh/Dept. Then select whether to print the entire File or Single Record. If single record, Enter Key of Veh/Dept numbers when prompted.

This report lists a date range (file initialization date to current) and the contents of the vehicle file in an abbreviated three-column format (when printed at the TopKAT report printer:

Column 1		Column 2		Column 3	
VEH	Vehicle number	KEY	Key number	L	Limitation Code
DEPT	Department	PIN	PIN	A	Authorization Code
~ or ~	~ OR ~				
ACCT	Account				
BOD	Beginning Odometer	MF	Maximum Fuelings/Day	C	Check Digit
LOD	Last Odometer	FT	Fuelings Today	ST	Lockout Status
QTY	Quantity	FTD	Fuelings To Date		

Note: When initiating the vehicle file report using the Manager's Key, PIN numbers are visible. When initiating the report using the Report Key, the PIN field contains asterisks instead of the PIN value.

Vehicle Lockout Report (VEH LOCKOUT REPORT)

This report shows the lockouts for the vehicle file records with the status field set to LOCKED OUT in the following format:

- Date
- Key number
- Department/account
- Vehicle number

Manual Entry Lockout Report (MAN LOCKOUT REPORT)

This report shows the manual entry file records with the status field set to LOCKED OUT. The report title contains the name of your manual entry (for example: Employee Lockout Report). It contains the following information:

- Date
- Manual entry field name and number
- Department*

** This field remains as Department regardless of what you select in the SELECT NAME setup prompt.*

Department Manual Entry Report (DEPT MAN ENT RPT)

This report shows the manual entry file sorted by department. It contains the following information:

- Date range
- Department*
 - Manual entry field name and value
 - Quantity
- Total quantity by department
- Grand total quantity for all departments

** This field remains as Department regardless of what you select in the SELECT NAME setup prompt.*

Note: If Man Chk not Enabled appears, the file is currently disabled. To enable the file, enter Setup/Manual Entry Config/Manual Entry Check and select Required.

Manual Entry Report

This report lists the contents of the manual entry file in a multi-column format with the following information:

- Manual entry name
- Department*
- Lockout status
- PIN
- Total quantity
- Fuelings to date

** This field remains as Department regardless of what you select in the SELECT NAME setup prompt.*

When selecting this report, you can select File or Single Record. If you select Single Record, enter manual entry number when prompted.

Note: If Man Chk not Enabled appears, the file is currently disabled. To enable the file, enter Setup/Manual Entry Config/Manual Entry Check and select Required.

Events Report

This report lists up to 100 system events (with 10 being the system default).

Possible system events are as follows. Events in bold are normal system events; other events may indicate problems.

RESET, TEST	BACKUP, TRANSACTIONS
RESET, CPU RESET INSTR	RESTORE, TRANSACTIONS
RESET, CPU CLOCK LOSS	PUMP DISABLED, #xx (where xx = 01-08)
RESET, UNDEFINED	STACK OVERFLOW
RESET, HALT	EXIT DIAGNOSTICS
RESET, SOFTWARE WATCHDOG	OPERATING MODE CHANGED
RESET, POWER UP	PUMP DISABLED, #NN
RESET, EXTERNAL	INVALID TRANS POINTER
SIGN ON, COM1	UNINITIALIZED INTERRUPT
SIGN ON, COM2	SPURIOUS INTERRUPT
MANAGER MODE	SATELLITE #N ON-LINE
BUS ERROR	SATELLITE #N OFF-LINE
SOFTWARE INTERRUPT	UNDEFINED
ILLEGAL CPU INSTR	MODEM INITIALIZATION, NO RESPONSE
DIVIDE BY ZERO	MODEM INITIALIZATION, STRING 1 FAILED
BACKUP, SYSTEM CONFIGURATION	MODEM INITIALIZATION, ASTRING 2 FAILED
RESTORE, SYSTEM CONFIGURATION	MODEM INITIALIZATION, SUCCESSFUL
BACKUP, VEH/MAN FILE	MODEM INITIALIZATION, STRINGS OK - NO
RESTORE, VEH/MAN FILE	Q1

13 – Diagnostics and Utilities

About Diagnostics and Utilities

Diagnostics allow the user to test various components of the TopKAT. Some diagnostics are available via the keypad; others are available only by the DIAG terminal command. Keypad diagnostics are available at the master unit as well as all satellite units. The TopKAT provides the following diagnostic tests and utilities (listed alphabetically for easy reference):

- Beeper Test (terminal only)
- Datakey Read (keypad); Datakey Test (terminal)
- Deadman Timer Reset (terminal only)
- DIP Switch Test (keypad and terminal)
- Display Test (keypad and terminal)
- Health Light Test (terminal only)
- Key Read Totalizer and Reset Key Read Totalizer (keypad only)
- Keypad Test (keypad and terminal)
- PCMCIA Test (keypad and terminal)
- PCU Status (keypad only)
- Port Test (keypad and terminal)
- Printer Test (terminal only)
- Program Version (keypad only)
- RAM Test (keypad and terminal)
- ROM Test (keypad and terminal)
- PCMCIA Backup/Restore utility (optional; keypad only)

This section presents the keypad commands first, then the terminal commands. Commands are shown in their functional sequence.

Accessing the Keypad Diagnostics Menu

When accessing diagnostics and utilities functions, pumps must be stopped. If pumps are in run status (enabled) when entering diagnostic mode, they are returned to run status when diagnostic mode is exited. If your TopKAT is a satellite, it must be offline to run diagnostics (remove the port 2 connector and wait until the display shows OUT OF SERVICE).

Keypad Diagnostics Menu

To access the Keypad Diagnostics Menu, proceed as follows:

- 1 Access the Main Menu. Use arrow keys to display **COMMAND: DIAGNOSTICS**. Then press **ENTER**.

If no transactions are in progress, pumps are automatically stopped. If there are transactions in progress, access to these functions is denied.

- 2 Use the up and down arrow keys to scroll through the **DIAGNOSTIC** command choices. Press **ENTER** when the required command is displayed.
- 3 To exit from the **DIAGNOSTICS** commands, press **PREV** as many times as necessary.

Keypad: PCU STATUS

Use this command to run a test on the pump control unit. The system will respond as to whether the pump control unit is communicating (UP) or not communicating (DN).

At PCU STATUS, press **ENTER**. The system displays 1:UP or 1:DN.

Keypad: RAM TEST

Use this command to test the RAM module to make sure each location can be read from and written to.

- 1 At RAM TEST, press **ENTER**. The system displays RAM PASSED or RAM FAILED.
- 2 Press **ENTER** to continue.

Keypad: ROM TEST

Use this command to read each location in the program chip (ROM), calculate a checksum, and compare it to a checksum inserted in the program chip at the factory.

- 1 At ROM TEST, press **ENTER**. The system displays ROM PASSED or ROM FAILED.
- 2 Press **ENTER** to continue.

Keypad: DIP SWITCH TEST

Use this option to display each switch (SW1) on the CPU PCB and its current status.

- 1 At DIP SWITCH TEST, press **ENTER**. The prompt for the first switch (MANAGER) appears. Use the up or down arrow keys to display other prompts (SW1-2, PRINTER, MODEM, PORT 2 BAUDRATE, PORT 3 BAUDRATE, SWITCH).
- 2 At the MANAGER, PRINTER, and MODEM selections, press **ENTER** to display if the switch is ENABLED (open) or DISABLED (closed). The SW1-2 prompt indicates UP (open) or DN (closed). Press **ENTER** again or **PREV** to return to the switch prompt level.
- 3 At the PORT 2 BAUDRATE and PORT 3 BAUDRATE selection, press **ENTER** and then use the arrow keys to select the required baud rate. Press **ENTER** again or **PREV** to return to the switch prompt level.
- 4 At the SWITCH selection, press **ENTER**. A 2-line display appears showing the settings read when the system is first powered up and the current settings for each switch (0=closed; 1=open).

Keypad: KEYPAD TEST

Use this command to display the information received at the keypad.

- 1 At KEYPAD TEST, press **ENTER**.
Any keys pressed at the keypad display on the LCD display.
- 2 Press **ENTER** twice to exit this test.

Keypad: DISPLAY TEST

Use this command to verify the display by displaying each character in the ASCII set.

- 1 At DISPLAY TEST, press **ENTER**. Sequences of characters display on the LCD.
- 2 Pressing any key except ENTER starts/stops display sequences. ENTER exits back to the display test menu.

Keypad: KEY READ TOTALIZER

Use this command to display the number of times your key receptacle has been used, since the last reset.

At KEY READ TOTALIZER, press **ENTER**. The key read total is displayed.

Reset Key Read Totalizer

After displaying the key read totalizer, you can reset the totalizer by pressing **1 2 3** and **ENTER**. The system responds Reset Totalizer? PRESS [YES] OR [NO]. Select the appropriate response.

Keypad: PROGRAM VERSION

Use this command to display the program version.

At PROGRAM VERSION, press **ENTER**. The program version information is displayed.

Keypad: PORT TEST

Use this command to verify that the serial ports on the Comm board are functioning properly. Tests are available for Ports 1, 2, and 3 on a standalone TopKAT; ports 1 and 3.

- 1 Remove the connector from the port being tested.
- 2 Plug in the loopback jumper to port connector. Be sure K1 and K2 port jumpers are jumpered correctly for the port.
- 3 Access the diagnostic menu as described previously.
- 4 At PORT TEST, press **ENTER**. Use the up or down arrow keys to select the required communications port and press **ENTER**. The system responds...please wait, followed by TEST PASSED or TEST FAILED.

Keypad: DATAKEY READ

Use this command to read and display the data from a key inserted into the receptacle.

- 1 At DATAKEY READ, press **ENTER**.
The system displays "INSERT KEY and Press ENTER (ESC to exit)."
- 2 Insert the key to be read and press **ENTER** to read, **ESC** to exit. If manager's key was used to access diagnostics, it must be re-inserted to exit this test. If no key is inserted for 30 seconds, test is aborted.

The key data is displayed in the following format:

```
T=0 S=9999 K=00002
P=027753 L=027987
```

Where: T is the key type; S is the system ID number; K is the key number; P is the previous odometer entry; L is the last odometer entry.

Key Type	Description
0	Vehicle key (TopKAT) or a single key (FleetKey)*
1	Employee key**
2	Vehicle key (FleetKey)* Information loaded into TopKAT vehicle file
3	Supervisor key
4	Delivery key
5	Dipstick key
6	Password key**
7	Encoding key**
8	Manager key
9	Report key

* Type 0 or 2, encoded for a FleetKey system will work as an encoded vehicle key for TopKAT.

** Key types 1, 6, and 7 are invalid key types for a TopKAT system.

Keypad: PCMCIA TEST

Use this command to run a test on the PCMCIA card where the system writes and reads back data to and from the card without destroying the contents of the card.

- 1 Insert the PCMCIA card into the socket on the PCMCIA board until it snaps into place.
- 2 At PCMCIA TEST, press **ENTER**.
The system performs checks on the card and displays a series of messages (that is, powering up card, testing card, please wait). Then one of the following messages appears:
 - PCMCIA CARD PASSED or PCMCIA CARD FAILED
 - CARD NOT INSERTED
Action: Insert card.
 - BATTERY DEAD
Action: Replace battery in PCMCIA card.
 - BATTERY LOW PRESS ESC [ENTER TO CONT]
Action: Battery on PCMCIA card is low. Backup/restore may be able to take place, but is risky. Press ESC to exit and replace battery. Press ENTER to continue the test.
 - WRITE PROTECTED
Action: Card is write-protected and test cannot proceed. Alter the write-protect status of the card and retry the test.

Accessing the Utilities Menu

When accessing diagnostics and utilities functions, pumps must be stopped. If no transactions are in progress, pumps are automatically stopped. If there are transactions in progress, you are prompted to stop them. If pumps are in run status when entering diagnostic mode, they are returned to run status when diagnostic mode is exited.

To access the Utilities Menu, proceed as follows:

- 1 Access the Main Menu.
- 2 When COMMAND: UTILITIES appears, press **ENTER**.
- 3 At the PCMCIA BAK/RESTORE command, press **ENTER**.

PCMCIA Backup/Restore Utility (optional)

The PCMCIA backup and restore utility allows you to back up critical system files to a PCMCIA data card. This option is valid only at standalone or master TopKAT units. The four files are vehicle, manual entry, transaction, and system configuration.

PCMCIA backups can be done using a 128K SRAM cards or a 256K card. Because of the method used to back up the data, two 128K cards are required. You can back up all four files (two per card) as shown in either example below:

128K Card 1	128K Card 2
Vehicle	Manual Entry
Sys Config	Transaction

128K Card 1	128K Card 2
Vehicle	Manual Entry
Transaction	Sys Config

All four files will fit on a 256K card. A kit is available containing two 256K cards. It is recommended that each 256K card be used alternately for backups so that at any time, the user has two previous backups.

Restoring system configuration data from backups, where the current version of software is different from the backup version, is accomplished as follows.

- Restoration of data from an older version is allowed, but you will not have any backup data for features not included in the prior backup. For example, if features a-x were backed up and the new system contains features a-z, features a-x would be restored and features y and z would still need correction.
- Backup of a newer version to an older version is not allowed. For example, if you have a backup of version 1.1, you cannot restore it back to a version 1.0 system.

PCMCIA Backup

To perform PCMCIA Backup, proceed as follows:

- 1 Access the Utilities menu.
- 2 At the PCMCIA BAK/RESTORE command, press **ENTER**.
- 3 Insert the PCMCIA card into the socket on the PCMCIA board.
- 4 Press **ENTER**. The system displays PCMCIA BACKUP SYSTEM CONFIG. Use the arrow keys to scroll between the other backup options (VEHICLE FILE, MANUAL FILE, TRANS FILE and ALL FILES).
Note: NOTE: ALL FILES option is available only for 256K card.
- 5 Select the required option and press **ENTER**. The system displays the backup option selected, and a confirmation prompt. Select **YES** to continue, or **NO** to change the option. The system responds powering up card...please wait.

- 6 If data is detected on the PCMCIA card, the system will query **OVERWRITE CARD DATA?** [YES] [NO]. Select the appropriate response. If YES, the backup occurs and the system responds **BACKUP COMPLETED**.
- 7 Remove the PCMCIA card from the slot by pressing the release tab at the top of the card socket. Store the backup in a safe location. If required, you may slide the switch at the top of the PCMCIA card to the left to write-protect the backup.

PCMCIA Restore

To perform PCMCIA Restore, proceed as follows:

- 1 Access the Utilities menu.
- 2 At the PCMCIA BAK/RESTORE command, press **ENTER**, then press the arrow key until **RESTORE** appears. Then press **ENTER**.
- 3 Insert the PCMCIA card into the socket on the PCMCIA board.
- 4 The system displays **PCMCIA RESTORE SYSTEM CONFIG**. Use the arrow keys to scroll between the other restore options (**VEHICLE FILE**, **MANUAL FILE**, **TRANS FILE** and **ALL FILES**).
Note: ALL FILES option is available only for 256K card.
- 5 The system prompts **SYS CONFIG RESTORE [YES] OR [NO]**. Select YES. The system displays **Restoring Sys.Config**.
- 6 If the system mode is different from the one being restored, the system prompts: **RES CHANGED MODE PRESS [YES] OR [NO]**.
- 7 Select the required option and press **ENTER**. The system displays the restore option selected, and a confirmation prompt. Select YES to continue, or NO to change the option. The system responds **powering up card...please wait**. The restore occurs and the system responds **RESTORE COMPLETED**.
- 8 Remove the PCMCIA card from the socket by pressing the release tab at the top of the card socket.

There are several messages that may appear during these operations. The messages and their suggested actions are:

BATTERY DEAD

Replace the PCMCIA card's battery.

BATTERY LOW PRESS ESC (ENTER TO CONT)

Battery on PCMCIA card is low. Backup/restore may be able to take place, but is risky. Press **ESC** to exit and replace battery. Press **ENTER** to continue the backup/restore.

CARD NOT INSERTED

Insert card, or if card is inserted, verify that it is inserted correctly. Then re-attempt the action.

INVALID BACKUP

Message occurs during restore when an invalid backup is detected. This message could result if the card failed internal data checks performed by the system before restore. It could also result from a card being inserted with an incorrect backup (for example, a system configuration backup when a vehicle file backup is requested).

INVALID VERSION

Message occurs during restore when an invalid backup version is detected. When a restore is attempted, the system internally checks the backup version used; if it is incompatible, this message appears.

NOT A 256K CARD

A backup or restore of all four files has been requested with a 64K or 128K card inserted.

TOO MANY RECORDS

May occur when restoring a V1.0 or V1.1 backed-up transaction file to a V2.0 or greater system due to the department/account field being increased from one digit to four digits. In V2.0, a maximum of 1650 transactions can be stored. If there are more than 1650 transactions between the safe and next pointers (refer to [“Move Trans Pointer”](#) on [page 56](#)), the safe pointer must be moved closer to the next pointer so the distance between them is 1650 or less.

WRITE PROTECTED

Message occurs during backup only if the write protect switch on the PCMCIA card is set to WP. Remove card, slide WP switch to the right and replace card in slot. Retry procedure.

Accessing the Terminal Diagnostics Menu

When accessing diagnostics functions, pumps must be stopped. If pumps are in run status (enabled) when entering diagnostic mode, they are returned to run status when diagnostic mode is exited. Terminal diagnostics are effective only at the master TopKAT when used with the master/satellite option.

To access the Terminal Diagnostics Menu, proceed as follows:

- 1 Type **DIAG**; press **ENTER**.
 - If pumps are not stopped, you are prompted to stop pumps by typing Y for yes or N for no.
 - If transactions are in progress, you are queried “Are you sure?. Type **Y** to enter diagnostics mode or **N** to exit.”

The diagnostic Main Menu displays.

```
MAIN MENU
1. RAM TEST
2. ROM TEST
3. DIP SWITCH TEST
4. HEALTH LIGHT TEST
5. BEEPER TEST
6. DISPLAY TEST
7. KEYPAD TEST
8. DATAKEY TEST
9. PORT TEST
10. DEADMAN TIMER TEST
11. PCMCIA TEST
12. PRINTER TEST
13. QUIT (RESETS SYSTEM)
```

- 2 Select the required choice. The test options are covered alphabetically in this section. When you select the Quit option, the system resets and the **SIGN ON**: prompt displays.

At the bottom of most test screens, a status line is present which indicates the status of the current test. Possible values are Idle, Testing, Stopped, Passed, or Failed.

- **Idle** displays when the submenu for a test is displayed.
- **Testing** displays while the test is running.
- **Stopped** displays when a test is stopped using the Start/Stop option.
- **Passed** or **Failed** displays as appropriate for the designated test.

Terminal: RAM TEST

Use this command to test the RAM module to make sure each location can be read from and written to. This test is a non-destructive memory test that tests memory word storage and address lines. If problems are detected in the single pass mode, the test is stopped.

- 1 On the diagnostic Main Menu, select **RAM TEST**.
The RAM Test Menu appears.

```
RAM TEST (non-destructive)
1. SINGLE PASS
2. CONTINUOUS PASSES
3. STOP/START
4. RESTART
5. QUIT TO MAIN MENU

Test Count: 000005      Fail: 000000
```

- 2 Select the required option.
 - **Single Pass** executes one pass through the test and stops. The Fail indicator is incremented by one and the expected and read codes contain values. If the Stop/Start option is selected, the status line indicates the system is stopped. Pressing Stop/Start again displays the previous final test status and starts the test from the next memory location.
 - **Continuous Passes** continually runs successive test passes until one of the other options is selected. The Test Count/Fail display is updated after a successful pass. When the Stop/Start selection is pressed in continuous pass mode, Stop/Start completes the test that is currently running or restarts testing when pressed again.
 - **Restart** test option re-initializes the Test Count/Fail display, then executes the last selected test option.

Terminal: ROM TEST

Use this command to test the ROM. The ROM Test option validates the System Program by reading each byte stored in the programs memory while generating a checksum. It compares this checksum with the checksum stored in the last two bytes of the program memory.

- 1 On the diagnostic Main Menu, select **ROM TEST**.
The ROM Test Menu appears.

```
ROM TEST
1. SINGLE PASS
2. CONTINUOUS PASSES
3. STOP/START
4. RESTART
5. QUIT TO MAIN MENU

Test Count: 000005      Fail: 000000
```



- 2 Select the required option.
 - **Single Pass** executes one pass through the test and stops. The Test Count/Fail display is updated after each pass. If the Stop/Start option is selected, the status line indicates the system is stopped. Pressing Stop/Start again displays the previous final test status. In the single pass mode, if the test stopped because of errors, the Fail indicator will be incremented by one.
 - **Continuous Passes** continually runs successive test passes until one of the other options is selected. The Test Count/Fail display is updated after each pass. In continuous pass mode, Stop/Start completes the test that is currently running or restarts testing when pressed again.
 - **Restart** test option re-initializes the Test Count/Fail display, then executes the last selected test option.

Terminal: DIP SWITCH TEST

Use this option to initiate a display showing the current position of each DIP switch (SW1) on the CPU PCB. When a switch position is changed, the display reflects that change.

- 1 On the diagnostic Main Menu, select **DIP SWITCH TEST**.
The DIP switch display appears (see [Figure 13-1](#)), followed by the message “Press any key for Main Menu.”

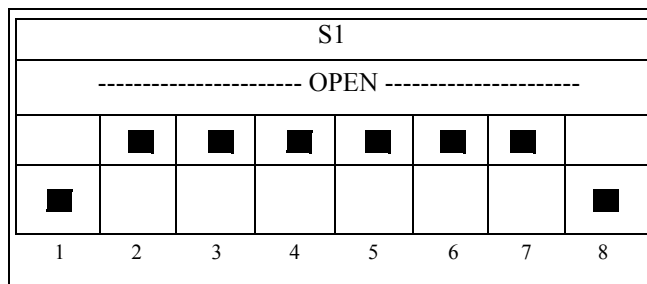
Figure 13-1: DIP Switch Display



- 2 When a switch position is changed, the display reflects that change. Press any key to return to the diagnostics Main Menu.

Terminal: HEALTH LIGHT TEST

Use this option to check the status of the yellow health light located on the CPU board.

- 1 On the diagnostic Main Menu, select **HEALTH LIGHT TEST**.
The Health Light Test Menu appears:

```

HEALTH LIGHT TEST
1. TURN HEALTH LIGHT ON
2. TURN HEALTH LIGHT OFF
3. READ HEALTH LIGHT STATUS
4. QUIT TO MAIN MENU
    
```

- 2 Select the required option.
 - Option 1 turns the health light on and displays its status on the terminal screen.
 - Option 2 turns the health light off and displays its status on the terminal screen.
 - Option 3 displays the status of the health light (should cycle between on and off).

Terminal: BEEPER TEST

Use this option to test the beeper located on the CPU board.

- 1 On the diagnostics Main Menu, select **BEEPER TEST**.
The beeper test menu contains three options:

```
BEEPER TEST
1. TURN ON BEEPER
2. TURN OFF BEEPER
3. QUIT TO MAIN MENU
```

- 2 Select the action required. Select 3 to return to the diagnostics main menu.

Terminal: DISPLAY TEST

Use this option to verify the display by displaying each character in the ASCII set.

- 1 On the diagnostic Main Menu, select **DISPLAY TEST**.
The Display Test Menu appears:

```
DISPLAY TEST
1. HORIZONTAL SCROLL
2. VERTICAL SCROLL
3. STOP/START DISPLAY
4. QUIT TO MAIN MENU
```

- 2 Select the required option.
 - Horizontal scroll scrolls a test pattern across the top line from the right side to the left side, then to the bottom line from the right to the left side.
 - Vertical scroll scrolls a test pattern from the bottom to the top of the display.
 - Stop/start display stops and starts the test from the point where it left off.

Pressing either one of the horizontal or vertical scroll selections again restarts the test. The status line reads Testing while the test is in progress and Passed or Failed when it completes.

Terminal: KEYPAD TEST

Use this command to display the information received at the keypad.

- 1 Select **KEYPAD TEST**; press **ENTER**.
A box appears in the center of the screen and the following message displays:
“Waiting for TopKAT keypad entry, press any terminal key to exit.”
Note: Any keys pressed at the keypad display on the terminal.
- 2 Press any terminal key to exit this test.

Terminal: DATAKEY TEST

Use this option to read and display the data from a key inserted into the receptacle.

- 1 On the diagnostic Main Menu, select **DATAKEY TEST**.
The Datakey Test screen appears:

```

DATAKEY TEST

Key Type:
System Id:
Key #:
CRC1:
Last Odometer:
Previous Odometer:
CRC2:

Insert Datakey to read
Press any key for Main Menu...

```

- 2 Insert and turn key to be read.
The key data is displayed in the format shown above. It also displays a table which contains all the datakey bytes. The CRC1 and CRC2 fields display valid or invalid.

Terminal: PORT TEST

Use this option to verify that the serial ports are functioning properly. Tests are available for Ports 1, 2, and 3 (Not available on Port 3 for master. Port 3 is connected to terminal).

- 1 Remove the connector from the port being tested.
- 2 Plug in the loopback jumper to the port connector. Ensure that the K1 and K2 port jumpers are jumpered correctly for the port.
- 3 On the diagnostic Main Menu, select **PORT TEST**.
The Port Test Menu appears:

```

PORT TEST

1. PORT 1 TEST
2. PORT 2 TEST
3. PORT 3 TEST
4. QUIT TO MAIN MENU

```

- 4 Select the required port to test.
The Port x Test menu appears:

```
PORT x TEST
1. SINGLE PASS
2. CONTINUOUS PASSES
3. STOP/START
4. RESTART
5. QUIT TO PORT TEST MENU

Port Status - Baud rate: 2400CD: Active
Test Count: 000005      Fail: 000000
Address Failed: xxxxxx      expected: XXXX      read: XXXX
```

- 5 Select the required option.
The port baud rate and Carrier Detect (CD) status are displayed on the first line below the test menu.
 - Single Pass executes one pass through the test and stops. A Test Count/Fail display is updated. If data errors are detected, the expected and read values are displayed on the third line below the menu.
 - Continuous Passes continually runs successive test passes until one of the other options is selected. The Test Count/Fail display is updated after each pass.
 - Stop/Start stops testing in the continuous passes mode or restarts continuous testing when pressed again.
 - Restart test option re-initializes the Test Count/Fail display, then executes the last selected test option.

Terminal: DEADMAN TIMER RESET

Use this option to test the deadman timer. Selecting this test allows the deadman timer to expire and resets the system.

- 1 Type **DIAG** then press **ENTER**. Select Yes to enter Enhanced Diagnostics. The Diagnostic Menu appears.
- 2 Select **DEADMAN TIMER TEST**, press **ENTER**. The deadman timer test menu appears. The system displays “System reset should occur within 1 sec. after test execution.”
- 3 Select **EXECUTE DEADMAN TIMER TEST**. The system should reset and the SIGN ON: prompt should appear. Sign on using your sign on code.

Terminal: PCMCIA TEST

Use this command to run a test on the PCMCIA card where the system writes and reads back data to and from the card without destroying the contents of the card.

- 1 Insert the PCMCIA card into the socket on the PCMCIA board until it snaps into place.
- 2 On the diagnostic Main Menu, select **PCMCIA TEST**.
The Select Card Size Menu appears.

```
SELECT CARD SIZE
64K
128K
256K
QUIT TO PCMCIA MENU
```

- 3 Select the appropriate card size.
This information should appear on the PCMCIA card label (if no size is indicated, assume that the card is 128K).
The PCMCIA Test Menu appears.

```
PCMCIA TEST
1. SINGLE PASS
2. CONTINUOUS PASSES
3. STOP/START
4. RESTART TEST
5. QUIT TO MAIN MENU

Size 128K    Card Status: OK
Battery Status: OK

Test Count 000001  Fail: 000000
Address Failed: xxxxxx    expected: XXXX    read: XXXX
```

- 4 Select the required test option.
 - **Single Pass** executes one pass through the test and stops. A Test Count/Test Fail display is updated and the Address Failed line contains data values.
 - **Continuous Passes** continually runs successive test passes until one of the other options is selected. The Test Count/Test Fail display is updated after each pass.
 - **Stop/Start** stops a continuous passes test that is currently running or restarts that test when pressed again.
 - **Restart** test option re-initializes the Test Count/Test Fail display, then executes the last selected test option.

Terminal: PRINTER TEST

Use this option to perform tests on the printer.

- 1 On the diagnostic Main Menu, select **PRINTER TEST**.
The Printer Test Menu appears.

```
          PRINTER TEST
1. PRINT TEST PATTERN
2. PRINTER PAPER ADVANCE
3. RESET PRINTER
4. QUIT TO MAIN MENU
```

- 2 Select the required option.
 - **Print Test Pattern** prints a test pattern of printable characters.
 - **Printer Paper Advance** sends a CR to the printer to advance it one line.
 - **Reset Printer** activates the printer reset line, then releases it. The Printer Status line should indicate the printer is NOT READY, then reset, and then indicate READY.

14 – Terminal Commands

About Terminal Commands

The TopKAT Terminal Commands can be accessed by connecting a terminal to Port 2 or Port 3 on the Communications Interface PCB. Locate the RS-232/RS-422 jumpers on the Communications I/F PCB and make sure they are set correctly and that the terminal cable is connected to the correct connector (RS-232 or RS-422).

Terminal commands may be entered in their entirety or in an abbreviated format. The abbreviated format is shown in each command heading and as the entry in the first step of each command sequence.

Several control key sequences are available to aid you in navigating the terminal commands.

- You can move backward and forward through the terminal command sequence by pressing CTRL-O or the UP arrow key repeatedly until the required level is reached. Scrolling back at a prompt where there is no previous prompt redisplay the prompt.
- CTRL-L and ENTER moves you to the prior command level.
- Pressing CTRL-C returns you to the CMD> prompt.

For example: if you are using the COntfigure SYstem command and have selected All and are at one of the subprompts, pressing CTRL-O or up arrow returns you to the previous prompt. Pressing CTRL-L and ENTER returns you to the main prompt (Configure System menu). Pressing CTRL-C returns you to the CMD> prompt.

With all of the print commands, you can use the “|more” modifier to display a set number of lines on the screen. When you are done viewing the screen contents, pressing ENTER will restart the screen display and increment one line; pressing the spacebar will increment the screen by the number of lines specified in the L MO command (Example of command with more modifier: PR TR | more).

Ensure that you check the CPU Board Port x Baud Rate settings so they match the Terminal baud rate.

Accessing the Terminal Commands

The Terminal Commands can be accessed by one of two methods:

- Set the manager's mode switch (SW1-1) to OPEN. The terminal displays CMD>. Close the manager mode switch.
- At the terminal SIGN ON prompt, enter the password and press **ENTER**. The terminal displays CMD>. Type the short or long form of any terminal commands in this section.

Note: When you sign on in command mode, the system automatically signs off for you after 5 minutes of keyboard inactivity.

The commands are presented alphabetically for ease of reference. In all sequences, press ENTER after typing unless told otherwise.

Add Inventory (A I)

Use this command to add an inventory amount to a tank either as a delivery or inventory adjustment.

- 1 Type **A I**.
The system prompts ENTER TANK #.
- 2 Enter the tank number for the inventory addition.
The system prompts ENTER AMOUNT (XXXXX.XXX).
- 3 Enter the amount of the delivery or adjustment.
The system prompts DELIVERY (Y)es or (N)o:
- 4 Type **Y** for delivery or **N** for adjustment.

Add RECOrd (A REC)

Use this command to add a record to either the vehicle or manual entry file.

- 1 Type **A REC**. The system prompts Select File - (V)ehicle or (E)mployee:.
Note: The file name of the second file will differ depending on which name is used for your manual entry file. These examples use the manual entry filename EMPLOYEE.
- 2 Type **V** or **E**. The appropriate prompt appears depending on what you select. A list of prompts that appear and their entries follow:

Vehicle File Prompt (V)	Enter
ENTER KEY #	1- to 5-digit key number
ENTER VEHICLE #	1- to 5-digit vehicle number
ENTER DEPT #/ACCT #	4-digit department or account number
ENTER LIMIT	1-digit limitation code (refer to "Limitation Codes" on page 36)
ENTER AUTHORIZATION	1-digit authorization code (refer to "Authorization Codes" on page 37)
ENTER CHECK DIGIT	1 digit (refer to "Check Digit" on page 37)
ENTER LOCKOUT STATUS	1 character: A for active; L for locked out
ENTER PIN	4-digit personal identification number
ENTER BEGINNING ODOMETER	6-digits
ENTER LAST ODOMETER	6-digits
ENTER TOTAL QUANTITY	8-digits (xxxxx.xxx)
ENTER MAX FUELINGS/DAY	2-digits (1 to 15)
ENTER # FUELINGS TODAY	2-digits; cleared between 00:00 and 00:05 daily
ENTER #FUELINGS TO DATE	3-digits; cumulative; reset when totalizer reset

Manual Entry (Employee Prompt) (E)	Enter
ENTER MANUAL ENTRY #	1- to 4-digit manual entry field
ENTER DEPT #	4-digit department number
ENTER LOCKOUT STATUS	1 character: A for active; L for locked out
ENTER PIN	4-digit personal identification number
ENTER TOTAL QUANTITY	8-digits (xxxxx.xxx)
ENTER #FUELINGS TO DATE	3-digits; cumulative; reset when totalizer reset

When you complete the entire series of entries for the record, the first prompt reappears.

- 3 Repeat this sequence from step 2; or if you are adding only one record, press **ENTER** at the ENTER KEY # prompt to return to the CMD> prompt.

CLear File (CL F)

Use this command to clear (erase) all records from the selected file. Once cleared, file data cannot be retrieved unless you have a PCMCIA backup card or a PC/900 software backup.

- 1 Type **CL F**.

The system displays the following menu:

```
CLEAR FILE
1. VEHICLE
2. EMPLOYEE (OR MANUAL ENTRY NAME)
3. TRANSACTIONS
4. EVENTS
5. ALL

ENTER (1-5) :
```

- 2 Type the selection number for the file to be cleared.
The system prompts: ARE YOU SURE? (Y)es or (N)o.
- 3 Type the appropriate response. The system responds **COMMAND COMPLETED** and redisplay the menu. Press **ENTER** to exit.

CLear Key (CL K)

Use this command to clear the key read totalizer, which records all uses of the key in the receptacle.

- 1 Type **CL K**. The system prompts (Y)es or (N)o.
- 2 Type the appropriate response. The system responds **COMMAND COMPLETED**.

CLear Transaction In Progress (CL TIP)

Use this command to clear any transactions in progress. When you use this command, the system places an **UNASSIGNED TRANS** message in the transaction **ERROR** column. This command should be used with care as transactions may be lost. Contact Gasboy Technical Service before attempting this command.

- 1 Type **CL TIP**. The system prompts ARE YOU SURE? (Y)es or (N)o.
- 2 Type the appropriate response. Any transactions in progress are cleared. They are logged in the transaction file as unassigned transactions and the pump number, product, tank number, and quantity are recorded.

COntfigure Bulk (CO B)

Use this command to configure your system to accept bulk fueling. The PCU Type must be set to 4-hose mechanical or 2-hose mechanical to use bulk fueling.

- 1 Type **CO B**. The system prompts BULK FUELING? (Y)es or (N)o.
- 2 Type the appropriate response.

COntfigure LOGger (CO LOG)

Use this command to indicate whether the transaction logger (for direct printout mode) is enabled or disabled.

- 1 Type **CO LOG**. The system prompts ENABLE TRANS LOGGER (Y)es or (N)o: (Y).
- 2 Press **ENTER** to accept the default Y.

~ OR ~

Type N and press **ENTER**.

COntfigure MAnual (CO MA)

Use this command to indicate how the manual entry file is to be set up and handled.

- 1 Type **CO MA**.
The system prompts MANUAL ENTRY CHECK REQUIRED - (Y)es or (N)o: (Y)
- 2 Enter the appropriate response.
 - If you select Yes, a record must exist in the manual entry file. The entry made by the user at the keypad must match a record in the manual entry file.
 - If you select No, the user can enter anything at the manual entry prompt and it will be accepted.

The system displays a menu of manual entry field name choices.

```
MANUAL ENTRY NAME
1. EMPLOYEE #
2. JOB #
3. ACCOUNT #
4. AUXILIARY #
5. TRIP #
6. DRIVER #
7. MISC #

ENTER (1-7) :
```

- 3 Select the required manual entry field name by number and press **ENTER**.

Configure PCUs (CO PC) - Standalone Electronic; Master/Satellite Electronic; Mechanical PCUs

Use this command to identify the physical setup of your pumps.

- If you are using standalone with all mechanical pumps, PCU assignments are not needed; pump setup is done through the Pump File (refer to [“About the Pump File”](#) on page 49).
- If you are using the master/satellite option, this command works differently. Follow the steps below.

- 1 Type **CO PC**.
The system prompts with ENTER PUMP #:
- 2 Type the pump number and press **ENTER**.
The system prompts with ENTER PCU NO. (1):
- 3 Type the selected PCU number (1-8*) and press **ENTER**.
The system prompts with ENTER PCU SLOT (1):
Note: If you are using mechanical PCUs, this prompt will read 1-2.
- 4 Type the selected PCU slot and press **ENTER**.

Configure PCUs (CO PC) - Master/Satellite Mechanical; Master/Satellite Combination

Configure Master Unit for Mechanical Pumps

To configure Master Unit for Mechanical Pumps, proceed as follows:

- 1 Type **CO PC**.
When using the master/satellite option, the system displays the following menu:

```

          CONFIGURE PCUS
1. MASTER
2. SATELLITE
3. BOTH
ENTER (1-3) :

```

- 2 Select **1** for master and press **ENTER** (or select **3** for Both and then master prompts appear followed by satellite prompts).
- 3 Respond to the following prompts, pressing **ENTER** after each:

LOAD NO. OF PUMPS:	Type number of pumps connected to master (1 or 2).
LOAD BASE PUMP NO.:	Indicate the base pump number (01-99) for the master.
ENTER PUMP #:	Type the number of the pump.
PULSE RATE:	Type the required pulse rate.
PUMP SWITCH TIME:	Type a value from .1 to 1.0 (refer to “Pump Switch Timer Parameter” on page 20).

Configure Master Unit for Electronic Pump

To configure Master Unit for Electronic Pump, proceed as follows:

1 Type **CO PC**.

When using the master/satellite option, the system displays the following menu:

```

          CONFIGURE PCUS
1. MASTER
2. SATELLITE
3. BOTH
ENTER (1-3) :
```

2 Select **1** for master and press **ENTER**.

(Or select **3** for Both and then master prompts appear followed by satellite prompts.)

3 Respond to the following prompts, pressing **ENTER** after each:

LOAD NO. OF PUMPS: Type number of pumps connected to master (1 or 2).

LOAD BASE PUMP NO.: Indicate the base pump number (01-99) for the master.

ENTER PUMP #: Type the number of the pump.

ENTER PCU SLOT (1): Type the selected PCU slot.

Note: When configuring master/satellite combination, the master must be the electronic pump and all satellites must be mechanical.

Configure Satellite Unit for Mechanical Pumps

To configure Satellite Unit for Mechanical Pumps, proceed as follows:

1 Type **CO PC**.

The system displays the following menu:

```

          CONFIGURE PCUS
1. MASTER
2. SATELLITE
3. BOTH
ENTER (1-3) :
```

2 Select **2** for satellite and press **ENTER**.

3 Respond to the following prompts:

LOAD SATELLITE NO: Load number from 1 to 7, sequentially.

LOAD NO. OF PUMPS: Type number of pumps connected to this satellite.

LOAD BASE PUMP NO.: Indicate the base pump number (01-99) for this satellite.

ENTER PUMP #: Type the number of the pump.

PULSE RATE: Type the required pulse rate.

PUMP SWITCH TIME: Type a value from .1 to 1.0 (refer to "Pump Switch Timer Parameter" on [page 20](#)).

CO nfigure PIn (CO PI)

Use this command to indicate whether the system should lock out keys when 3 consecutive invalid PIN entries are made.

- 1 Type **CO PI**.
The system responds INVALID PIN LOCKOUT (Y)ES OR (N)O.
- 2 Type **Y** to lock out keys when 3 consecutive invalid PIN entries are made.

~ OR ~

Type **N** to ignore invalid PIN entries and allow retries.

CO nfigure SYstem (CO SY) - Standalone Electronic or Mechanical PCU

Use this command to configure the operating characteristics of your standalone system. If you have the master/satellite option, your prompts will differ. Refer to the command sequence following this one.

- 1 Type **CO SY**.
The system displays a menu containing the system parameters.

```

CONFIGURE SYSTEM

1. SITE NO.
2. SYSTEM ID
3. NO. OF PUMPS
4. BASE PUMP NO.
5. PUMP TIMEOUTS
6. NO. OF TANKS
7. POLL ADDRESS
8. NO. OF PCUS
9. ALL

ENTER (1-9) :
```

The next system prompt varies depending on the option you select.

- If you select option 9 (All), system parameters display one after the other until all are completed.
- Refer to the following table for guidance on what to enter for the other prompts. Descriptions of these parameters appear in “[Setup Menu](#)” on [page 30](#).

Selection	Prompt	Enter
1	LOAD SITE NO: (xxxx)	4-digit site number
2	LOAD SYSTEM ID (xxxx)	4-digit system ID, assigned at the factory
3	LOAD NO. OF PUMPS (x)	number of pumps supported by TopKAT
4	LOAD BASE PUMP NO: (xx)	base pump number (1-99)
5	LOAD PUMP TIMEOUTS (xxx)	time-out value
6	LOAD NO. OF TANKS (x)	number of tanks supported by TopKAT
7	LOAD POLL ADDRESS (xx)	poll address for computer communication (usually 01)
8	LOAD NO. OF PCUS (xx)	number of PCUs supported by TopKAT

- 2 After a selection is complete, the menu reappears. Press **ENTER** to exit.

COntfigure SYstem (CO SY) - Standalone Mechanical

Use this command to configure the operating characteristics of your standalone system. If you have the master/satellite option, your prompts will differ. Refer to the command sequence following this one.

1 Type **CO SY**.

The system displays a menu containing the system parameters.

```

          CONFIGURE SYSTEM

1. SITE NO.
2. SYSTEM ID
3. NO. OF PUMPS
4. BASE PUMP NO.
5. PUMP TIMEOUTS
6. NO. OF TANKS
7. POLL ADDRESS
8. ALL

ENTER (1-8) :

```

The next system prompt varies depending on the option you select.

- If you select option 8 (All), system parameters display one after the other until all are completed.
- Refer to the following table for guidance on what to enter for the other prompts. Descriptions of these parameters appear in [“Setup Menu”](#) on [page 30](#).

Selection	Prompt	Enter
1	LOAD SITE NO: (xxxx)	4-digit site number
2	LOAD SYSTEM ID (xxxx)	4-digit system ID, assigned at the factory
3	LOAD NO. OF PUMPS (x)	number of pumps supported by TopKAT
4	LOAD BASE PUMP NO: (xx)	base pump number (1-99)
5	LOAD PUMP TIMEOUTS (xxx)	time-out value
6	LOAD NO. OF TANKS (x)	number of tanks supported by TopKAT
7	LOAD POLL ADDRESS (xx)	poll address for computer communication (usually 01)

2 After a selection is complete, the menu reappears. Press **ENTER** to exit.

COntfigure SYstem (CO SY) - Master/Satellite Mechanical; Master/Satellite Combination

Use this command to configure the operating characteristics of your master/satellite system.

1 Type **CO SY**.

The system displays a menu containing the system parameters.

```

          CONFIGURE SYSTEM
1. SITE NO.
2. SYSTEM ID
3. NO. OF SATELLITES
4. PUMP TIMEOUTS
5. NO. OF TANKS
6. POLL ADDRESS
7. ALL

ENTER (1-7) :
```

The next system prompt varies depending on the option you select.

- If you select option 7 (All), system parameters display one after the other until all are completed.
- Refer to the following table for guidance on what to enter for the other prompts. Descriptions of these parameters appear in [“Setup Menu” on page 30](#).

Selection	Prompt	Enter
1	LOAD SITE NO: (xxxx)	4-digit site number
2	LOAD SYSTEM ID (xxxx)	4-digit system ID, assigned at the factory
3	LOAD NO. OF SATELLITES (x)	number of satellites supported by TopKAT
4	LOAD PUMP TIMEOUTS (xxx)	time-out value
5	LOAD NO. OF TANKS (x)	number of tanks supported by TopKAT
6	LOAD POLL ADDRESS (xx)	poll address for computer communication (usually 01)

2 After a selection is complete, the menu reappears. Press **ENTER** to exit.

COntfigure SYstem (CO SY) - Master/Satellite Electronic or Mechanical PCU

Use this command to configure the operating characteristics of your master/satellite system.

1 Type CO SY.

The system displays a menu containing the system parameters.

```

CONFIGURE SYSTEM
1. SITE NO.
2. SYSTEM ID
3. NO. OF PUMPS
4. BASE PUMP NO.
5. PUMP TIMEOUTS
6. NO. OF TANKS
7. POLL ADDRESS
8. NO. OF PCUS
9. NO. OF SATELLITES
10. ALL
ENTER (1-10) :

```

The next system prompt varies depending on the option you select.

- If you select option 10 (All), system parameters display one after the other until all are completed.
- Refer to the following table for guidance on what to enter for the other prompts. Descriptions of these parameters appear in [“Setup Menu” on page 30](#).

Selection	Prompt	Enter
1	LOAD SITE NO: (xxxx)	4-digit site number
2	LOAD SYSTEM ID (xxxx)	4-digit system ID, assigned at the factory
3	LOAD NO. OF PUMPS (x)	number of pumps supported by TopKAT
4	LOAD BASE PUMP NO. (xx)	base pump number (01-99)
5	LOAD PUMP TIMEOUTS (xxx)	time-out value
6	LOAD NO. OF TANKS (x)	number of tanks supported by TopKAT
7	LOAD POLL ADDRESS (xx)	poll address for computer communication (usually 01)
8	LOAD NO. OF PCUS (x)	number of PCUs supported by TopKAT (8 maximum)
9	LOAD NO. OF SATELLITES	number of satellites supported by TopKAT

2 After a selection is complete, the menu reappears. Press ENTER to exit.

CO nfigure Units (CO U)

Use this command to identify the units of measure to be used with your system. The system first displays a menu of categories, then displays a menu of choices within that category. Select the appropriate units for your application.

- 1 Type **CO U**. The system appears.

```
MEASUREMENT UNITS
1. DISTANCE
2. QUANTITY
3. DATE FORMAT
4. RATE
5. PUMP TIMEOUT MODE
6. ALL
ENTER (1-6) :
```

- 2 Select the required units category or select **6 (All)** to display the units selection prompts one after the other.
- 3 When the category menu displays, select the required units. Refer to “[MEASUREMENT UNITS \(only for Master and Standalone Modes\)](#)” on [page 33](#) for a list of available choices. After a selection is complete, the menu reappears. Press **ENTER** to exit.

DElete RECO rd (DE REC)

Use this command to delete a record from either the vehicle file or the manual entry file. Deletion criteria for the vehicle file is by key number or vehicle and department number combination; for the manual entry file, deletion criteria is by the manual entry field value.

- 1 Type **DE REC**.

The system prompts Select File - (V)ehicle or (E)mployee:.

Note: The file name of the second file will differ depending on which name is used for your manual entry file. These examples use the manual entry filename EMPLOYEE.

- 2 Type **V** or **E**.

The appropriate prompt appears depending on what you select.

- For the vehicle file (V), the prompts are Select (K)ey or (V)eh/dept (or (V)eh/Acct). Type **K** or **V**. At the next prompt, type the number.
- For the manual entry file (E), the prompt is the manual entry field name. Type the number.

The system prompts Are you sure? (Y)es or (N)o.

- 3 Type the appropriate response.

DIAGNOSTICS (DIAG)

Use this command to access the enhanced diagnostics available to the TopKAT via the terminal. The available diagnostics are covered in “[Diagnostics and Utilities](#)” beginning on [page 71](#).

- 1 Type **DIAG**, press **ENTER**.
The diagnostic Main Menu appears.

```
MAIN MENU
1.  RAM TEST
2.  ROM TEST
3.  DIP SWITCH TEST
4.  HEALTH LIGHT TEST
5.  BEEPER TEST
6.  DISPLAY TEST
7.  KEYPAD TEST
8.  DATAKEY TEST
9.  PORT TEST
10. DEADMAN TIMER TEST
11. PCMCIA TEST
12. PRINTER TEST
13. QUIT (RESETS SYSTEM)
```

- 2 Select the required option. The test options are covered alphabetically in this section.
- 3 When you select the Quit option, the system resets and displays the SIGN ON: prompt.

DISABLE PUMP (DIS PU)

Use this command to disable a pump for service or operational problems. If pump is already disabled, system displays PUMP ALREADY DISABLED.

- 1 Type **DIS PU**.
The system prompts ENTER PUMP #:
- 2 Type the required pump number.
The system responds PUMP DISABLED.

EDIT RECORD (ED REC)

Use this command to edit a record in the vehicle or manual entry file.

- 1 Type **ED REC**.
The system prompts Select File - (V)ehicle or (E)mployee:.
Note: The file name of the second file will differ depending on which name is used for your manual entry file. These examples use the manual entry filename EMPLOYEE.
- 2 Type **V** or **E**.
The appropriate prompt appears depending on what you select.
 - For the vehicle file (V), the prompts are Select (K)ey or (V)eh/dept (or (V)eh/Acct). Type **K** or **V**. At the next prompt, type the number.
 - For the manual entry file (E), the prompt is the manual entry field name. Type the number.

- 3 The prompts for the selected file type are displayed along with their current values. Press **ENTER** to accept the value and move to the next prompt. Change any values you wish.

When changing record values, after you change the required value, you may exit from the record without going through all of the fields.

- At the first position in a field, press the **CTRL** and **L** keys, then press **ENTER**. This saves your new entries and returns you to the beginning record prompt.
- To exit from a record and return to the command mode prompt, press the **CTRL** and **C** keys, then press **ENTER**.

ENable PProtection (EN PR)

Use this command to enable memory-full protection. The Memory-Full Protection feature is set to YES or NO.

- When set to YES, and transaction memory becomes full, the system will not accept further transactions and will display a MEMORY FULL message.
- When set to NO, and transaction memory becomes full, the system will start overwriting transactions, as new transactions occur.

Refer to [“Move PPointer \(M PO\)”](#) on [page 105](#) for ways to ease memory-full conditions.

ENable PUmp (EN PU)

Use this command to enable a pump after a disable command. If pump is already enabled, system displays PUMP ALREADY ENABLED.

- 1 Type **EN PU**.
The system prompts ENTER PUMP #:
- 2 Type the required pump number.
The system responds PUMP ENABLED.

EXit (EX)

Use this command to exit from command mode at the terminal.

Type **EX**.

The system exits command mode. If connected to Port 2 and the logger is enabled, direct printout mode is entered.

Help (H)

Use this command to display a listing of all terminal commands and their short forms (letters in uppercase).

Type **H**.

Refer to [“Appendix A: HELP Command”](#) for more information on this command.

Initialize File (I F)

Use INITIALIZE FILE only at initial startup or if doing periodic reconciliations. Be sure to print any required reports before running INITIALIZE FILE, otherwise you will end up with reports containing initialized values. When you select initialize pumps and your system has the master/satellite option, both master and satellite units are initialized.

1 Type **I F**.

The system displays the following menu:

```

INITIALIZE FILE

1. VEHICLE
2. MANUAL ENTRY
3. PUMPS
4. TANKS
5. ALL

ENTER (1-5:

```

2 Type the selection number for the file to be initialized.

The system responds INIT xxxxxx FILE, and prompts: ARE YOU SURE? (YES) or (N)o:

3 Type the appropriate response.

Initialize MODem (I MOD)

Use this command to send the modem strings that were input using the LOAD MODEM terminal command. When you do this, a result response displays on a second line.

Type **I MOD**.

The system displays "...please wait" and then one of the following result codes:

Result	Description
SUCCESSFUL	No command errors and Q1 is present in string 2
STRING 1 FAILED	Incorrect modem command was detected
STRING 2 FAILED	Incorrect modem command was detected
NO RESPONSE	Modem not present or not functioning; or Q1 is in string 1
STRINGS OK, NO Q1	Modem commands are correct but Q1 is not present in string 2

Load DAte (L DA)

Use this command to load the current system date.

- 1 Type **L DA**.
The system responds LOAD DATE (MMDDYY): (110105).
- 2 Type the date in the format shown in the system response.

Load MODem (LO MOD)

Use this command to input (load) one or two strings of modem commands up to 39 characters each. (The 39-character limitation is a modem requirement.) When the system is reset, these default modem strings are loaded:

String 1	AT&D2V1E0S0=1&C1B1
String 2	AT&WQ1

- The first string must include Q0 (allow result codes) as its first command.
 - The second string must include Q1 as the last command.
 - Do not use the following commands: &F, ATR, &V, and E1 (E1 is the default, however E0 is sent in the default initialization string to the TopKAT. Do not change the TopKAT string to E1).
- 1 Type **LO MOD**.
The system prompts LOAD INIT STRNG 1:
 - 2 Add or change commands and press **ENTER** or just press **ENTER** to leave the string as is.
The system prompts LOAD INIT STRNG 2:
 - 3 Add or change commands and press **ENTER** or just press **ENTER** to leave the string as is.

Note: If the modem is not enabled, not available will display when this command is entered.

Load MOre (L MO)

Use this command to indicate how many lines of text will appear on your terminal display screen when a |more command is used with the terminal print commands.

Type **L MO**.

When the system prompts LOAD MORE: (xx), enter a number from 1 to 24.

Load PAssword (L PA)

Use this command to set a password for accessing the terminal command set. While the keypad manager password is limited to four digits; the manager password for the terminal can be 1 to 10-alphanumeric characters. The terminal password is factory-set to GASBOY.

- 1 Type **L PA**.
The system responds LOAD PASSWORD:
- 2 Type the password (characters typed are not displayed).

~ OR ~

If you do not wish to change the password, press **ENTER** to retain the existing password.

Load PUmp (L PU)

Use this command to define the characteristics of your pump.

- 1 Type **L PU**.
The system responds LOAD PUMP TABLE ENTER PUMP #:
- 2 Type the pump number (01 - 99) and press **ENTER**.
The system responds ENTER TANK ASSIGNMENT: (x).
- 3 Enter the one-digit number for the tank containing the product.
The system responds ENTER TOTALIZER: (xxxxxxx.xxx).
- 4 Enter up to 10 digits for the totalizer value from the pump, if required.
The system responds ENTER TOTALIZER RESET DATE (mmddy): (xxxxxx).
- 5 Enter the current date (if setting the totalizer).
The system responds ENTER PULSE RATE.
- 6 Enter the pulse rate required.
The system responds ENTER PUMP SWITCH TIME.
- 7 Enter a value between 0.1 and 1.0.
The system displays the ENTER PUMP # prompt.
- 8 Repeat this process from step 2 until all pumps are defined.

Load RAnge (L RA)

Use this command to load a four-digit value for the maximum number of miles that may be traveled between fuelings for an odometer to be considered reasonable.

- 1 Type **L RA**.
The system responds LOAD REAS RANGE (xxxx):
- 2 Type a four-digit value.

Load RETry (L RET)

Use this command to load up to two digits for the number of times the odometer will be re-prompted for when an incorrect odometer has been entered.

- 1 Type **L RET**.
The system responds LOAD ODOM RETRIES (xx):
- 2 Enter the required number.

Load TAnk (L TA)

Use this command to indicate the inventory type and amount in each tank.

- 1 Type **L TA**.
The system displays LOAD TANK TABLE ENTER TANK #.
- 2 Type the appropriate tank number.
The system responds ENTER PRODUCT CODE (x):.
- 3 Enter the appropriate one-digit product code.
The system responds ENTER AMOUNT (xxxxxxx.xxx).
- 4 Enter the amount of product in the tank.
The system responds ENTER TANK #:.
- 5 Repeat this process from Step 2 until all tanks are defined.

Load TIME (L TIM)

Use this command to load the current system time.

- 1 Type **L TIM**.
The system responds LOAD TIME (HHMM): (xxxx)
- 2 Type the appropriate time in the format shown in the system response.

Load TRansactions (L TR)

Use this command to load the starting transaction number. When you first start up your system, this number is usually set to 0001 so the first transaction will be 0001; however it can be set to any number you wish.

- 1 Type **L TR**.
The system responds LOAD TRANS NUMBER: (xxxx)
- 2 Type a four-digit number for the first transaction.

Move POinter (M PO)

The TopKAT transaction file uses a circular memory storage technique that keeps accessible the last several hundred (at least 1650) transactions. There are two pointers in the transaction file: a safe pointer and a next transaction pointer.

- The safe pointer marks the beginning of the file location. The safe pointer remains fixed unless you move it using the Move Trans Pointer command.
- The next transaction pointer marks the next transaction to be assigned location. The next transaction pointer moves ahead each time a new transaction is received.

When you do a Print Transactions terminal command, your transaction printout begins at the safe pointer and ends with the last transaction before the next transaction pointer.

When the next transaction pointer reaches the safe pointer, and memory-full protection is enabled, the MEMORY FULL message displays and no more transactions can be stored or created. If memory-full protection is disabled, the safe pointer bumps up one transaction slot at a time as each new transaction is received thus overwriting existing transactions in memory.

To ease a memory-full condition, you can use the Move Trans Pointer command to move the safe pointer forward towards the next transaction pointer thus freeing up transaction storage space for new transactions. Before doing this; however, you need to poll your transactions. You can poll using the print transactions PR TR command. Transactions are read from the safe pointer to the next transaction pointer. Then use the MO PO command to relocate the pointer and make room for additional transactions. You can also poll using a Gasboy PC package. Transactions are copied to a file on the PC and the safe pointer is automatically moved to the next transaction pointer to free up memory for more transaction storage.

- 1 Type **M PO**.
The system responds MOVE TRANS POINTER (xxxx):
- 2 Type a new location (transaction number) for the pointer.

PRint DAte (PR DA)

Use this command to display the current system date and time on the screen.

Type **PR DA**.
The date and time appears.

PRint DEPTMan (PR DEPTM)

Use this command to display a report by Department and your Manual Entry field on the screen.

Type **PR DEPTM**.
The report appears.

Note: If this message appears: "Cannot execute, manual entry check not enabled," the file is currently disabled. To enable it, use the Configure Manual (CO MA) command and respond Yes to the Manual Entry Check Required prompt.

PRint DEPTVeh (PR DEPTV) or PRint Acctveh (PR A)

Use this command to display a report by Department or Acct and the Vehicle field on the screen.

Type **PR DEPTV** or **PR A**.
The report appears.

PRint EVents (PR EV)

Use this command to display a listing of system events on the screen. This command displays the last 100 system events.

Type **PR EV**.
The system events log appears.

Possible system events are as follows. Events in bold are normal system events; other events may indicate problems.

RESET, TEST	BACKUP, TRANSACTIONS
RESET, CPU RESET INSTR	RESTORE, TRANSACTIONS
RESET, CPU CLOCK LOSS	PUMP DISABLED, #xx (where xx = 01-08)
RESET, UNDEFINED	STACK OVERFLOW
RESET, HALT	EXIT DIAGNOSTICS
RESET, SOFTWARE WATCHDOG	OPERATING MODE CHANGED
RESET, POWER UP	PUMP DISABLED, #NN
RESET, EXTERNAL	INVALID TRANS POINTER
SIGN ON, COM1	UNINITIALIZED INTERRUPT
SIGN ON, COM2	SPURIOUS INTERRUPT
MANAGER MODE	SATELLITE #N ON-LINE
BUS ERROR	SATELLITE #N OFF-LINE
SOFTWARE INTERRUPT	UNDEFINED
ILLEGAL CPU INSTR	MODEM INITIALIZATION, NO RESPONSE
DIVIDE BY ZERO	MODEM INITIALIZATION, STRING 1 FAILED
BACKUP, SYSTEM CONFIGURATION	MODEM INITIALIZATION, ATRING 2 FAILED
RESTORE, SYSTEM CONFIGURATION	MODEM INITIALIZATION, SUCCESSFUL
BACKUP, VEH/MAN FILE	MODEM INITIALIZATION, STRINGS OK - NO
RESTORE, VEH/MAN FILE	Q1

PRint KEy (PR KE)

Use this command to print a last key read report. This display also includes a hexadecimal representation of the contents of the key registers, which is used for diagnostic purposes. When used with the master/satellite option, this report includes a Master/Satellite menu which the user can use to print the last key read at the master, a specific satellite or both.

Type **PR KE**.
The key read report appears.

PRint LOCKout (PR LOC)

Use this command to display the lockouts for the vehicle file, your manual entry file, or both files.

- 1 Type **PR LOC**.
The system displays the following menu:

```
          LOCKOUT REPORT
1.  VEHICLE
2.  MANUAL ENTRY
3.  BOTH

ENTER (1-3) :
```

- 2 Select the required choice.
The lockouts report appears.

PRint MAnual (PR MA)

Use this command to display a listing of the manual entry file.

- 1 Type **PR MA**.
The manual entry file listing appears.
- 2 Select (F)ile or (S)ingle.
If Single was selected, enter manual entry number, when prompted.
The manual entry file listing appears.

Note: If this message appears "Cannot execute, manual entry check not enabled," the file is currently disabled. To enable it, use the Configure Manual (CO MA) command and respond Yes to the Manual Entry Check Required prompt.

Print MODem (P MOD)

Use this command to print (display) the modem strings that are presently loaded.

Type **P MOD**.
Both strings display on the lines that follow.

PRint PUMp (PR PU)

Use this command to display a listing of your pump's characteristics.

Type **PR PU**.
The pump report appears.

PRint SYstem (PR SY)

Use this command to display a report containing all the system parameters and their current settings.

Type **PR SY**.

The system parameters report appears.

PRint TAnks (PR TA)

Use this command to display an inventory report for your tanks.

Type **PR TA**.

The inventory report appears.

PRint TRansaction (PR TR)

Use this command to display the transaction file.

Type **PR TR**.

The transaction file listing appears.

A list of transaction error codes appears in [“Appendix D: Transaction Error Codes”](#) on [page D-1](#).

PRint Vehicle (PR V)

Use this command to display the vehicle file.

- 1 Type **PR V**.
The system responds Select (K)ey or (V)eh/dept.
- 2 Select (F)ile or (S)ingle.
If Single was selected, enter key number or veh/dept number when prompted.
The system responds Select (K)ey of (V)eh/dept.
- 3 Type **K** or **V**.
The vehicle file displays sequentially according to the field you selected.

REcord ERror (RE ER)

Use this command to indicate whether your system will record error transactions (transactions without quantity) or simply discard them.

- 1 Type **RE ER**.
The system responds RECORD ERROR TRANSACTIONS (Y)ES OR (N)O: (x).
- 2 Type the required response.

RUN (RUN)

Use this command to start (or re-start after a stop) the site. During initial system power-up, if all essential system operating data is not correct, the system will not start and will have to be started with the RUN command after the fault conditions are corrected.

- 1 Type **RUN**.
The system responds ARE YOU SURE (Y)es or (N)o.
- 2 Enter the appropriate response.
If Yes is entered, the system restarts if it was stopped.

SElect Name (SE N)

Use this command to select the name of the field to be used as input or when searching the vehicle file and to print on reports.

- 1 Type **SE N**.
The system responds: SELECT FIELD NAME (D)EPARTMENT OR (A)CCOUNT: (A).
- 2 Type **D** or **A** as required.

STOP (STOP)

Use STOP to stop the fuel site. All ongoing transactions are terminated and site is stopped until a RUN command is issued.

- 1 Type **STOP**.
The system responds ARE YOU SURE? (Y)es or (N)o.
- 2 Respond appropriately.
If Yes is the response, the system responds with the following messages:
STOPPING PUMPS
please wait
SYSTEM STOPPED

SUsubtract Inventory (SU I)

Use this command to subtract an amount of fuel from your tank. You may need to do this to keep inventory amounts accurate (such as if the TopKAT was down and fuel was being accessed manually).

- 1 Type **SU I**.
The system responds SUBTRACT FROM INVTY. ENTER TANK #:
- 2 Type the tank number.
The system responds ENTER AMOUNT (xxxxx.xxx):
- 3 Type the amount to be subtracted.
- 4 Repeat this process from step 2 until all subtractions are recorded.

Appendix A: HELP Command

The following list shows the output of the HELP command, which contains the entire command and shows its shortened form with capital letters. For example, Add Inventory could be entered as any of the following:

- add inventory
- Add Inventory
- A I

Add Inventory	EXit	PRint DEPTMan
Add REcOrd	Help	PRint DEPTVeh
CLear File	Initialize File	PRint EVents
CLear Key	Initialize MODem	PRint KEy
CLear TIP	Load DAte	PRint LOCKout
Configure Bulk	Load MODem	PRint MANual
COntfigure LOGger	Load MOre	PRint MOD
COntfigure MANual	Load PAssword	PRint PUmp
COntfigure PCus	Load PUmp	PRint SYstem
COntfigure Pln	Load RAnge	PRint TAnk
COntfigure SYstem	Load RETry	PRint TRansactions
COntfigure Units	Load TAnk	PRint VehiCle
DElete REcOrd	Load TIME	REcord ERror
DIAGnostics	Load TRansactions	RUN
DISable PUmp	Move POinter	SElect Name
EDit REcOrd	PRint Acctveh	STOP
ENable Protection	PRint Date	SUbstract Inventory
ENable PUmp	PRint DEPTMan	

This page is intentionally left blank.

Appendix B: Menu Flow Chart

On this flowchart, menu items that branch horizontally are navigated to using the ENTER key; menu items that branch vertically are navigated to using the Up or Down arrow keys. Refer to “Navigating the Keypad” on page 25 for more keypad navigation information.

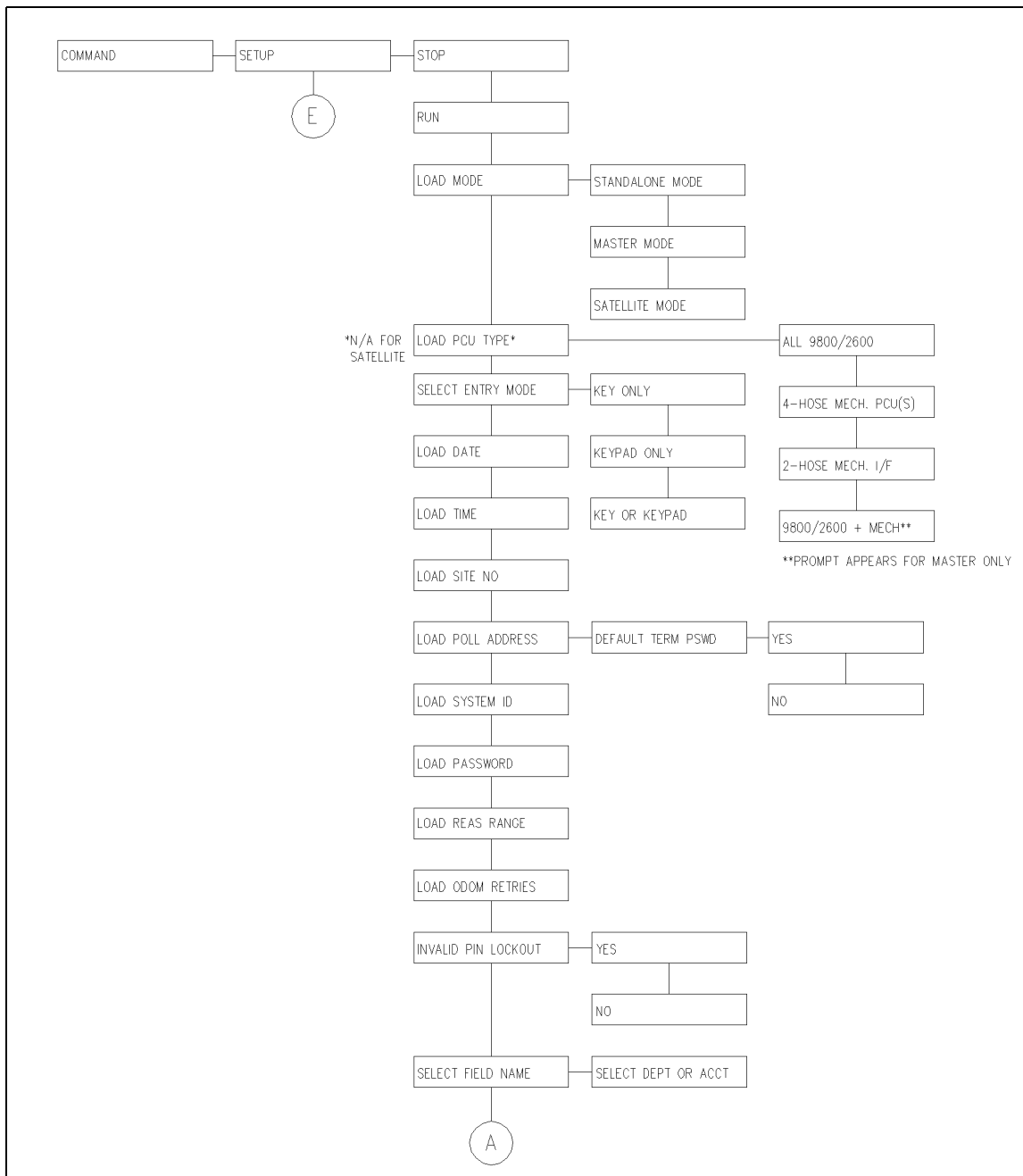

Appendix B: Menu Flow Chart

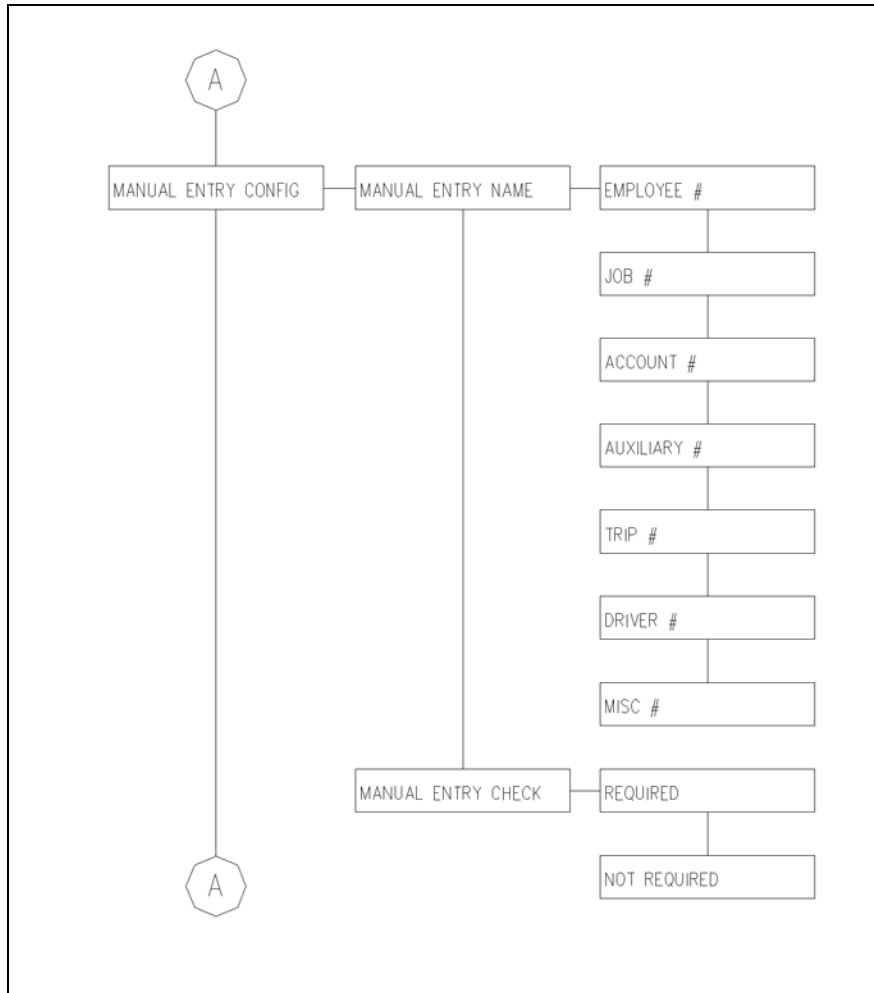

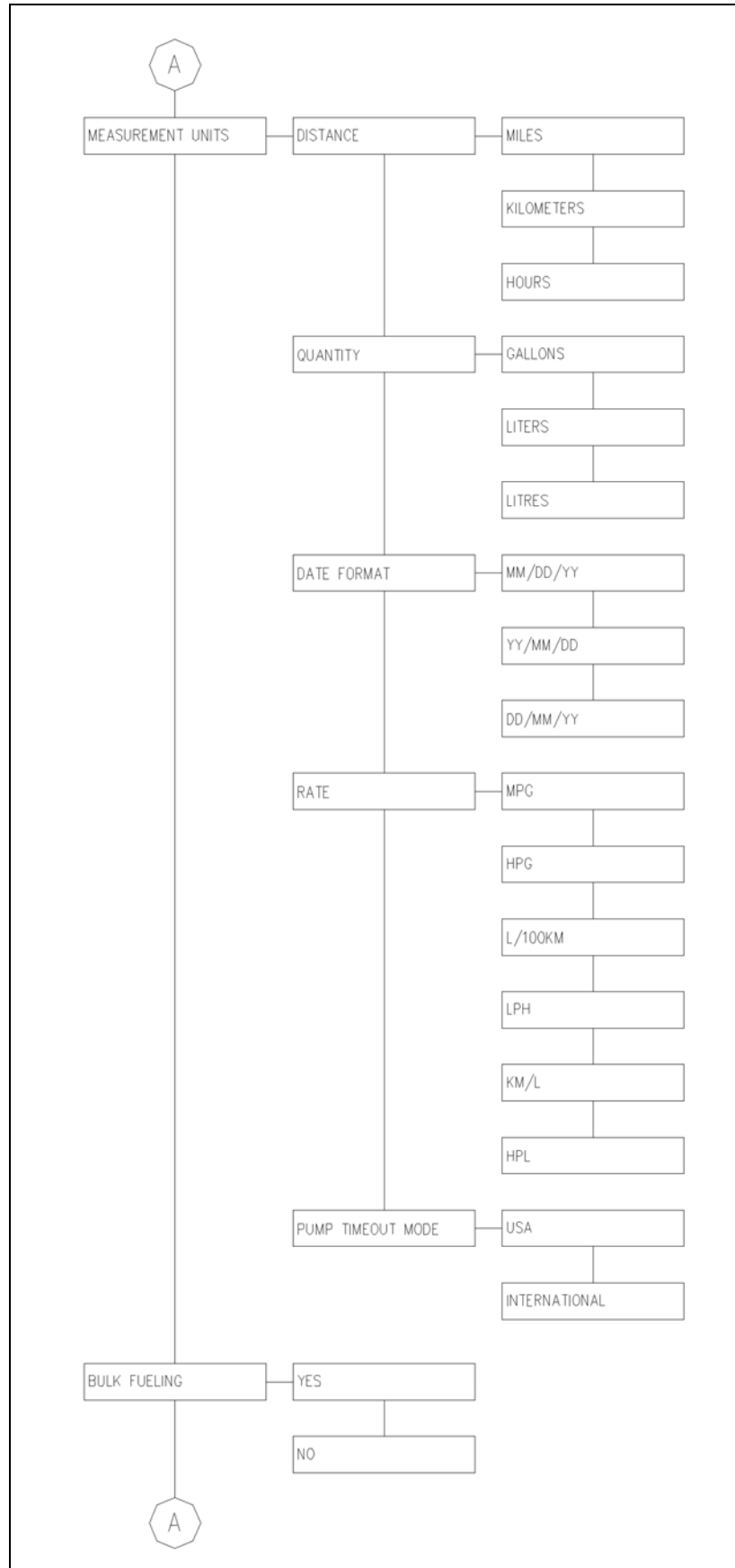

Appendix B: Menu Flow Chart

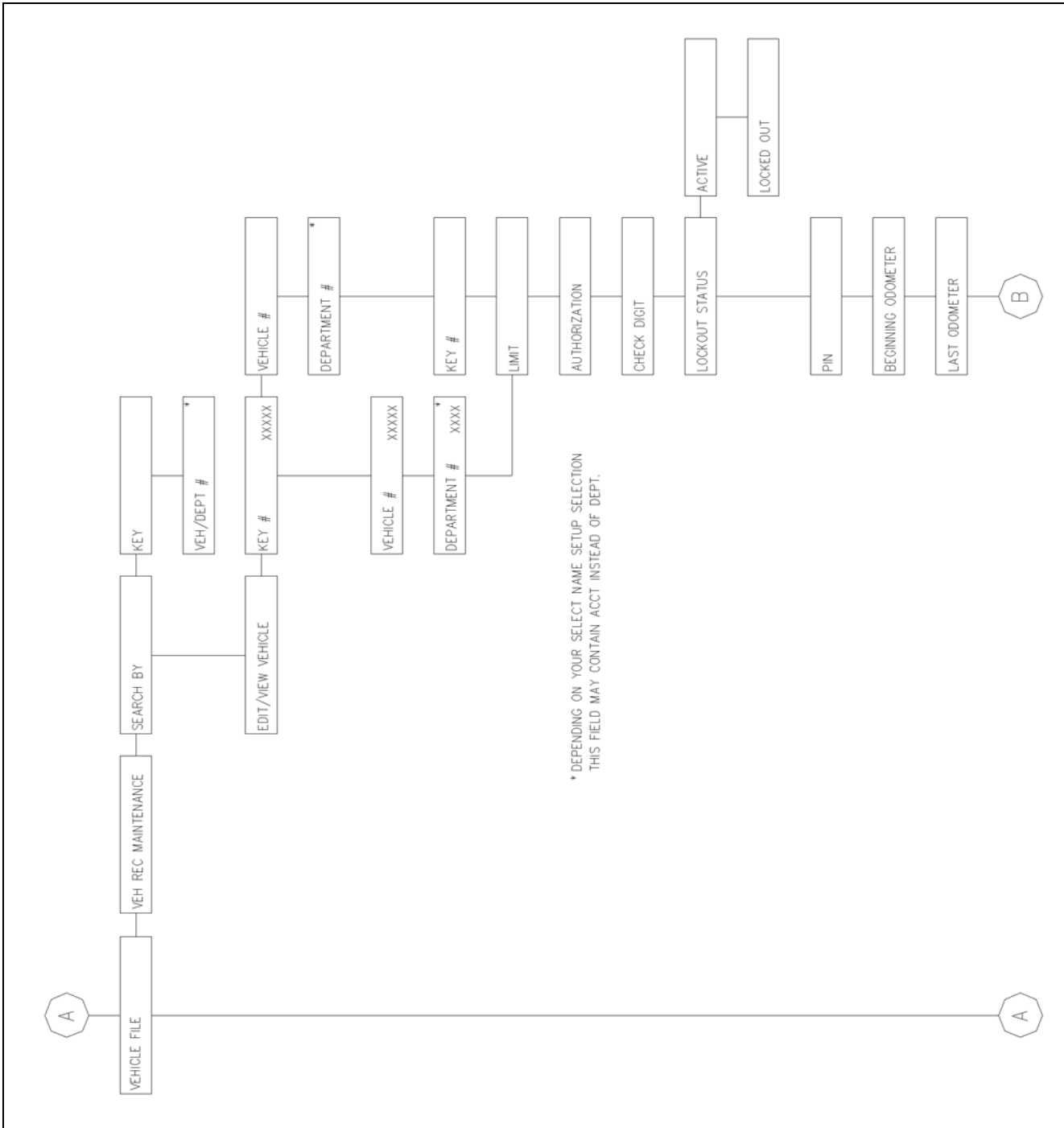

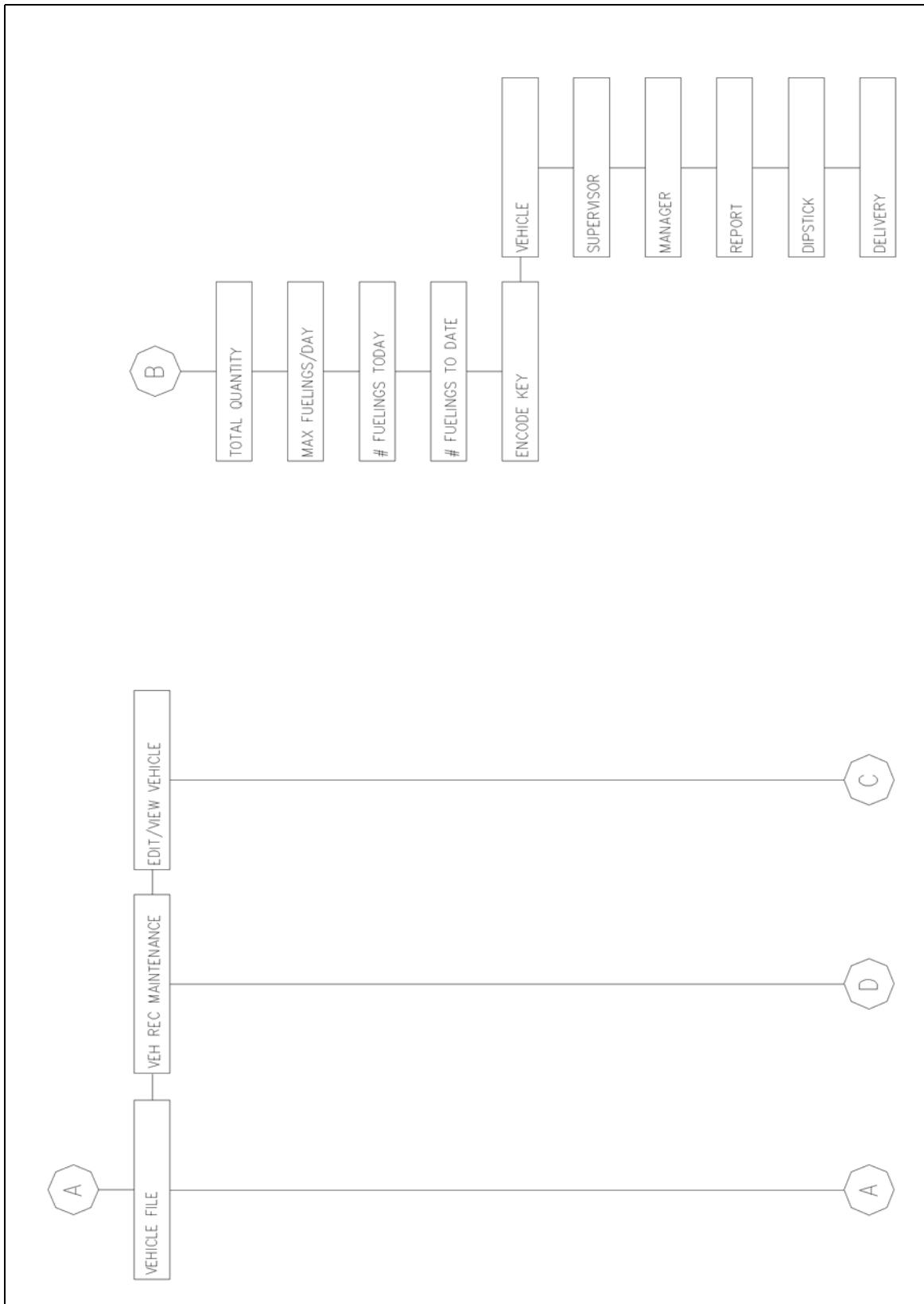

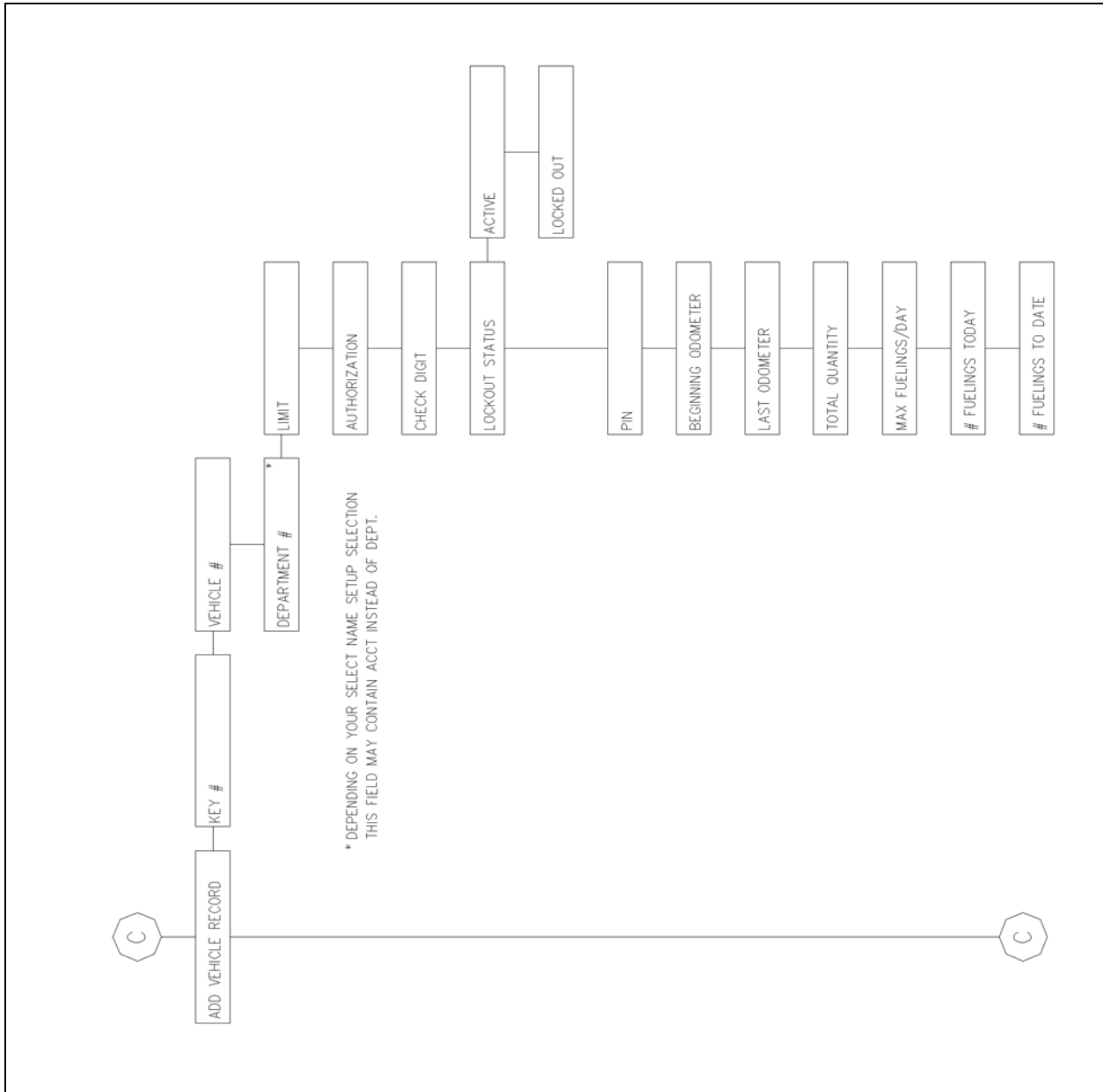

Appendix B: Menu Flow Chart

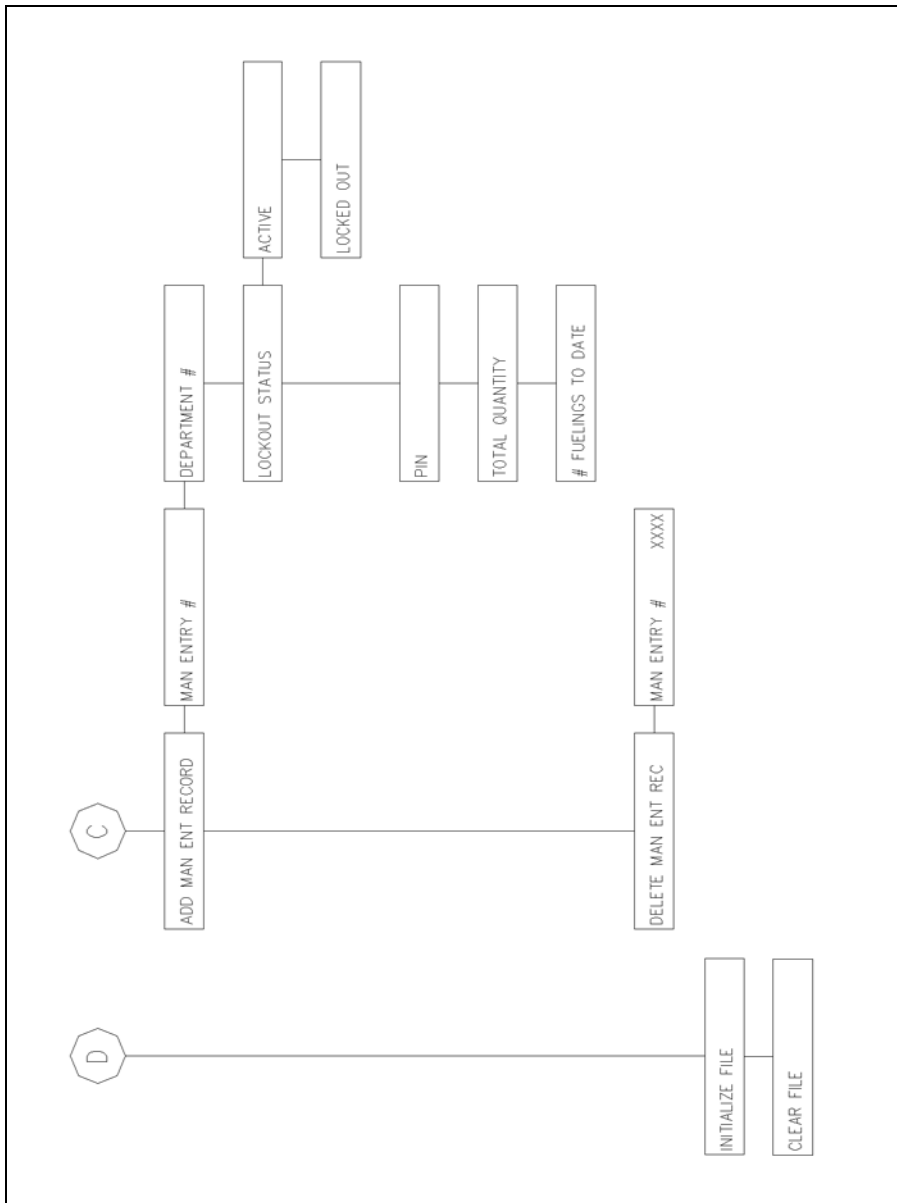

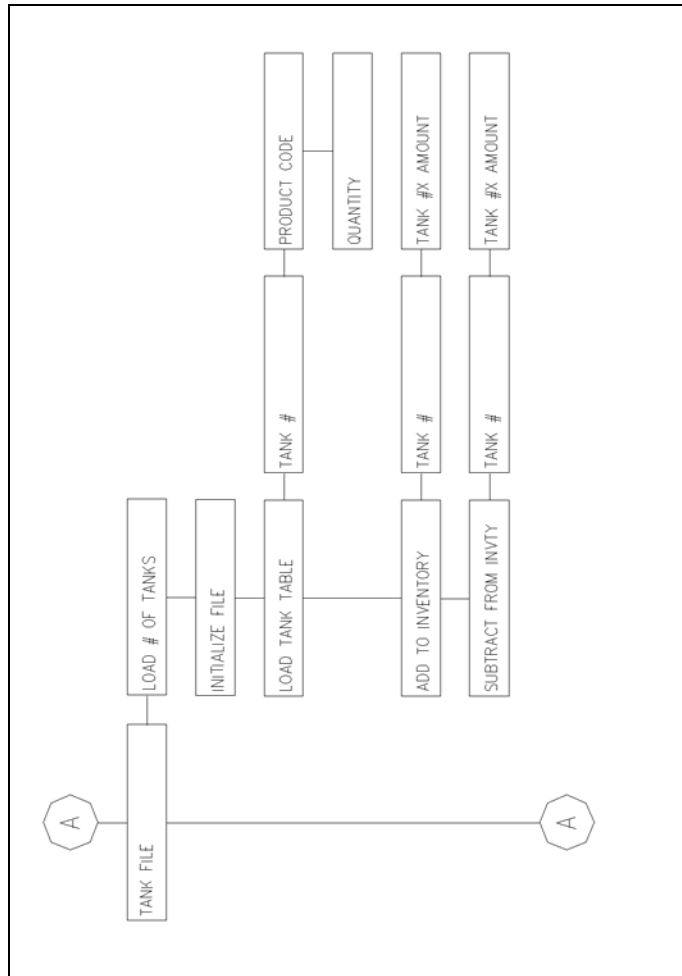

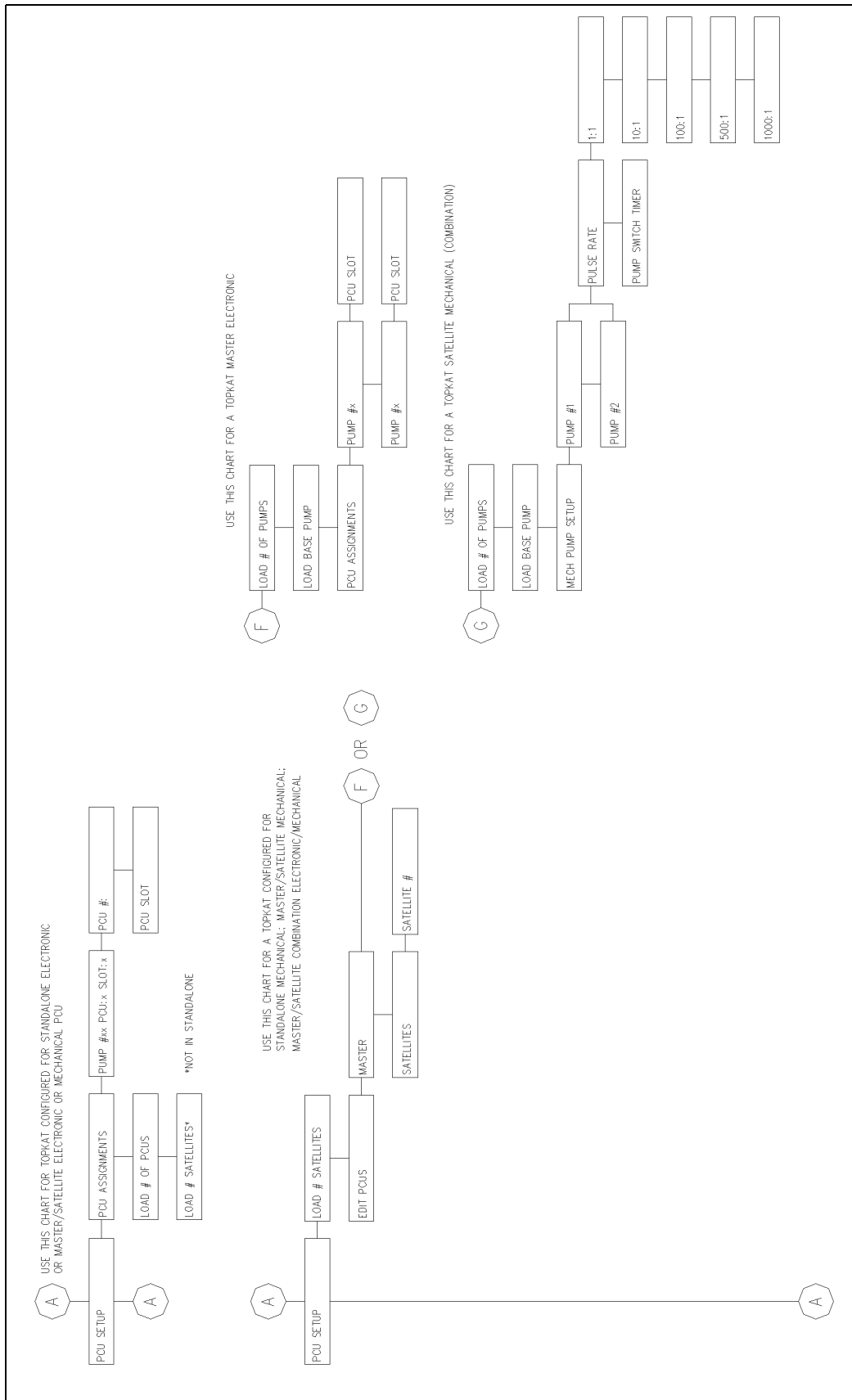

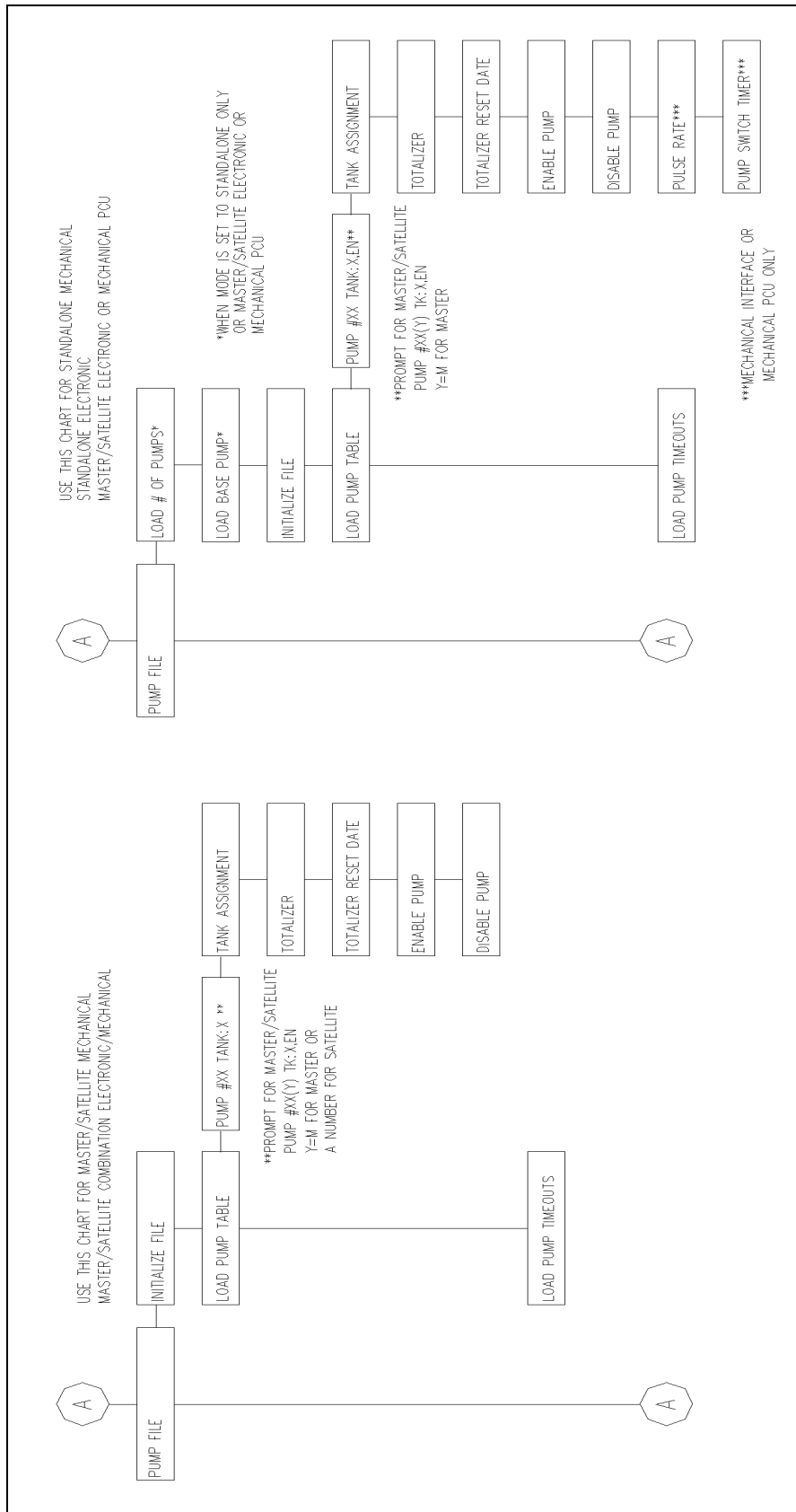

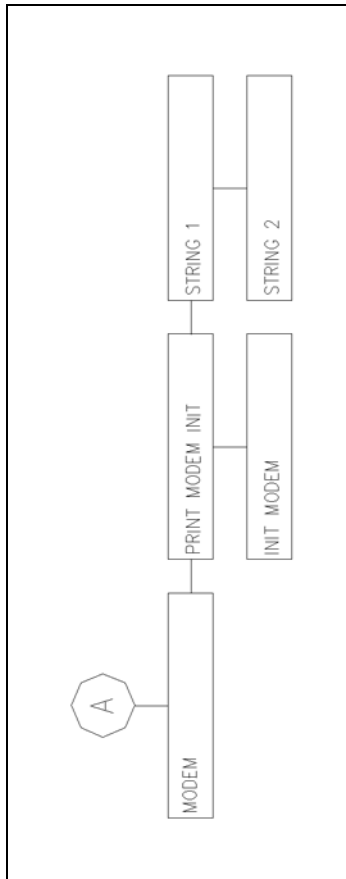

Appendix B: Menu Flow Chart

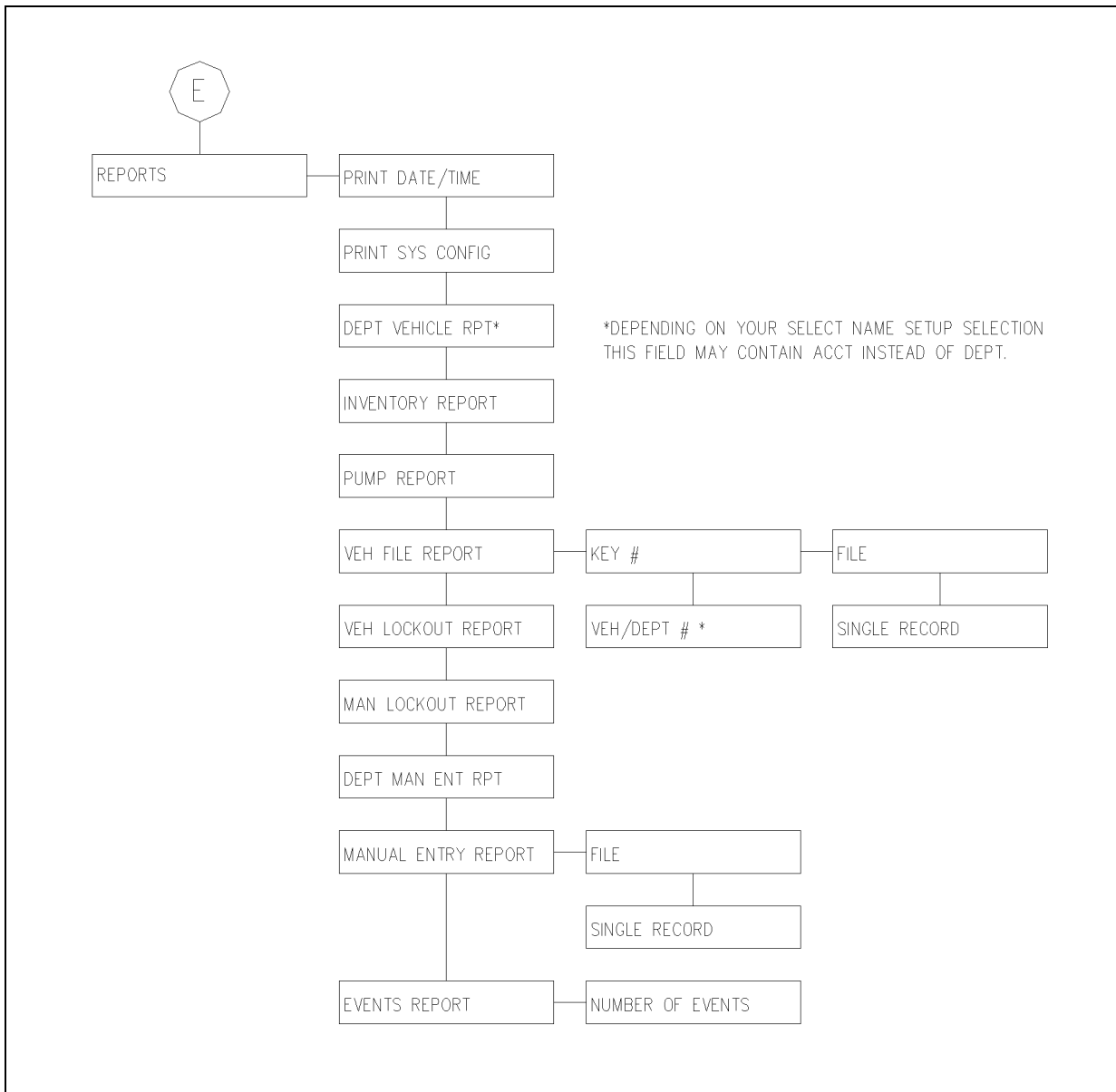

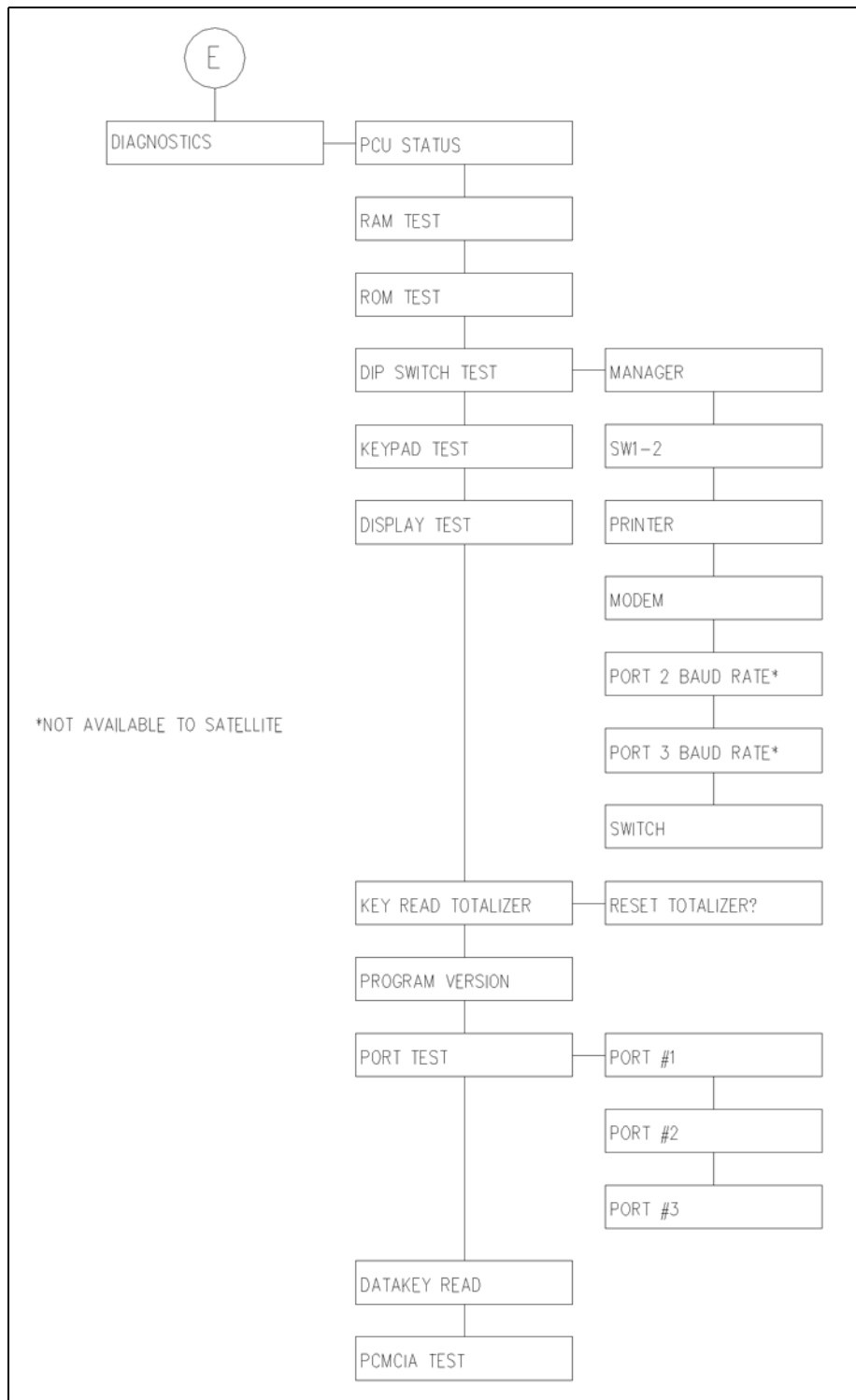

Appendix B: Menu Flow Chart

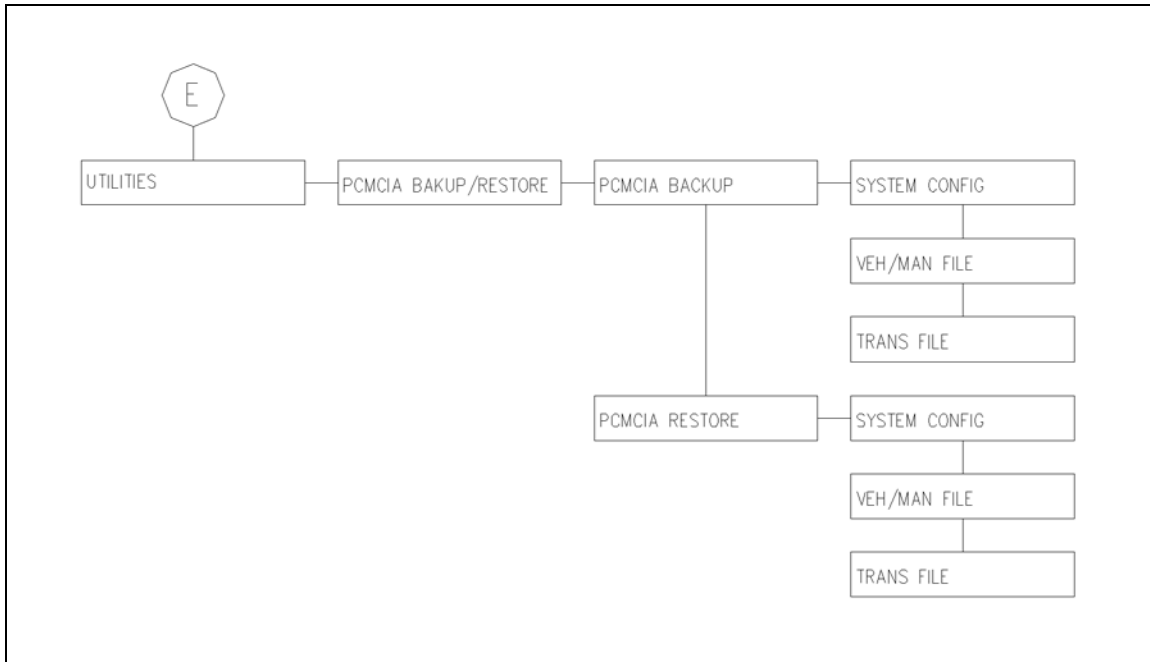

Appendix C: Display Messages

DAILY LIMIT EXC	User attempted to exceed the daily fuelings limit.
DELIVERY TRANS	A fuel delivery key was used to enter a fuel delivery and update the inventory totalizer.
DIPSTICK TRANS	A dipstick key was used to enter a dipstick reading.
DUPLICATE RECORD	User attempted to add a Vehicle or Manual Entry record that already exists.
EMERGENCY STOP	Stop command was executed when a transaction was pending.
EXIT DIAGNOSTICS	Enhanced diagnostics was exited.
FILE IS FULL	A user attempted to add a record to either the Vehicle or Manual Entry file and it was full.
FILE IN USE	User selected a file that was in use.
FILE IS EMPTY	A user attempted to edit or delete a record in a file that is empty.
FILE LOCKED	User attempted modify a file that is locked.
INVALID BACKUP	User attempted a PCMCIA restore and the backup file was not found or the data was invalid.
INVALID FUEL	User attempted access to fuel product not authorized to key; no access permitted.
INV KEY TYPE	A key was inserted that contained an invalid key type; no access permitted.
INVALID PIN	Incorrect PIN was entered; no access permitted.
INVALID PUMP	User selected a pump that does not exist.
INVALID SYSTEM ID	Invalid system identification on key used to access system; no access permitted. (Unauthorized access may have been attempted.)
INVALID TANK	An invalid tank number was selected during a fuel delivery or dipstick operation.
INVALID TRANS POINTERS	Transaction pointers were detected as being invalid and corrected.
INVALID VERSION	A user attempted a PCMCIA file restore operation with a file with a later back-up version number.
LIMIT CUTOFF	Limitation was reached, pump was turned off.
MANUAL ENTRY CHECK NOT ENABLED ~ or ~	Manual entry function was attempted when the manual entry check was not required.
MAN CHK NOT ENABLED	
MEMORY FULL	Transaction file is full.
MEMORY LOSS	TopKAT has a transaction pending of which 9800 has no knowledge.
MGR MODE SW NOT SET	User attempted to encode a key after entering the manager mode using a manager key.

Appendix C: Display Messages

NO RECORD FOUND	Manual entry record does not exist; user attempted to pump fuel using it or attempted to modify it.
NO VEHICLE RECORD	Vehicle record does not exist; user attempted to pump fuel using it or attempted to modify it.
ODOM RANGE ERROR	An incorrect odometer reading was entered.
OPERATING MODE CHANGED	Mode was changed by user.
POWER FAILED	9800 terminated a transaction as the result of a power failure at the 9800.
PUMPS DISABLED	User selected a pump that is disabled.
PUMP IN USE	User selected a pump that is in use.
PUMP OUT OF SERVICE	Pumps are stopped.
PUMP SWITCH ERROR	The pump handle was turned on before the time-out period expired.
RECORD LOCKED OUT	Manual entry record invalidated; no key access permitted.
SATELLITE #N OFFLINE	Satellite switched from online to offline.
SATELLITE #N ONLINE	Satellite switched from offline to online.
SPURIOUS INTERRUPT	Internal error; contact Gasboy Technical Support.
STACK OVERFLOW	Stack memory was exceeded.
SUPERVISOR KEY	A supervisor key was used to pump fuel.
TIMED OUT	The pump was not accessed (or turned off) within the time-out period.
TOO MANY RECORDS	PCMCIA card backup file contains too many records.
TRANS IN PROGRESS	A transaction is running.
UNASSIGNED TRANS	9800 has a transaction pending of which the TopKAT has no knowledge.
UNINITIALIZED INTERRUPT	Internal error; contact Gasboy Technical Support.
VEHICLE LOCKED OUT	Vehicle key invalidated; no access permitted.

Appendix D: Transaction Error Codes

Transaction error codes are two-digit codes that appear in the ERROR field (last two digits) of a transaction.

01	Timed out
02	Locked out
03	Invalid fuel
04	Pump in use
05	Invalid system ID
06	Limit cutoff
08	TTY command
09	Normal completed transaction
13	Odometer range error
14	Invalid PIN
17	Pump disabled
19	Invalid pump
22	Invalid key format
23	Emergency stop
31	Power fail
34	Invalid tank
35	Dipstick transaction
36	Invalid key type
51	Pump switch timer error
55	Delivery transaction
60	Memory loss transaction
61	Unassigned transaction
62	Dual pulser error
63	No record found
64	Daily limit exceeded
65	Pump out of service
67	Supervisor key transaction
68	PCU Type changed
69	Transaction aborted
99	Manually-entered transaction

Note: If an error code is noted with a number that does not appear in the list above, it is an unknown error that resulted from some form of data corruption. Discard the transaction; the data is unreliable.

This page is intentionally left blank.

Appendix E: Loading TopKAT Files from Microsoft® Excel®

Creating Your TopKAT Vehicle Records in Excel

- 1 Open Microsoft® (MS) Excel® and create a form (worksheet) that looks identical to the screen below.

	A	B	C	D	E	F	G	H	I	J	K	L	M	N
1	Key #	Veh #	Dept #	Limit Code	Auth Code	Check Code	Lockout Status	PIN	Beg. Odom	Last Odom	Qty.	Max Fuel	Today's Fuel	Fuel to Date
2	1-5 digits	1-5 digits	1-4 digits	1-digit	1-digit	1-digit	A or L	1-4 digits	1-6 digits	1-6 digits	1-8 digits	1-2 digits	1-2 digits	1-3 digits
3														
4														

- 2 Enter your vehicle information starting in row 3 of the form.
 - Each row will be for one vehicle record. All columns must be filled in according to the field sizes shown in row 2.
 - To display the header rows, split the screen by pulling the tiny bar in the right corner of the Excel chart until it is below row 2. The split screen appears as shown below.

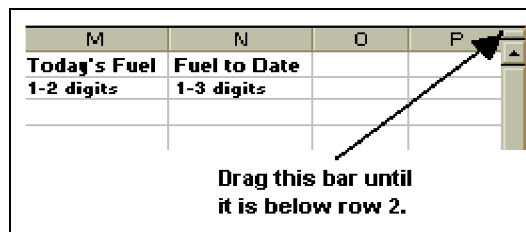

	A	B	C	D	E	F	Formula Bar	H	I	J	K	L	M	N
1	Key #	Veh #	Dept #	Limit Code	Auth Code	Check Code	Lockout Status	PIN	Beg. Odom	Last Odom	Qty.	Max Fuel	Today's Fuel	Fuel to Date
2	1-5 digits	1-5 digits	1-4 digits	1-digit	1-digit	1-digit	A or L	1-4 digits	1-6 digits	1-6 digits	1-8 digits	1-2 digits	1-2 digits	1-3 digits
3														
4														

- You can use the MS-Excel drag, copy, and paste functions to quickly fill in the form.

The following table describes the data to be entered in the columns. If you need additional information on these fields, refer to the appropriate section of this document.

Column	Data	Enter
A	Key #	1- to 5-digit key number (refer to "Sequential Numbering Hint" on page E-3)
B	Veh #	1- to 5-digit vehicle number
C	Dept #	1- to 4-digit department or account number
D	Limit Code	1-digit limitation code (refer to "Chart 1" on page E-2)
E	Auth Code	1-digit authorization code (refer to "Chart 2" on page E-2)
F	Check Code	1-digit check digit code (refer to "Chart 3" on page E-3)
G	Lockout Status	1-character lockout status
H	PIN	1- to 4-digit PIN
I	Beg. Odom	1- to 6-digit beginning odometer. Use 0 for this initial set up. This instructs the TopKAT to initialize the record using the odometer received the first time the key is used.
J	Last Odom	1- to 6-digit last odometer. Use 0 for this initial set up. This instructs the TopKAT to initialize the record using the odometer received the last time the key is used.
K	Qty.	8-digit (xxxxx.xxx) total quantity. Use 0 for initial setup.
L	Max Fuel	1- to 2-digit maximum fuelings per day (1 - 15). This is the maximum number of times the vehicle can fuel in a 24-hour period.
M	Today's Fuel	Enter 2-digit number for fuelings today. Use 0 for this initial file set up.
N	Fuel to Date	Enter 2-digit number for fuelings to date. Use 0 for this initial file set up.

Chart 1

Limit Code	Limit Cutoff Quantity
0	5
1	15
2	20
3	25
4	35
5	50
6	100
7	200
8	300
9	999

Chart 2

Auth Code	Product Codes Allowed
0	All
1	1
2	2
3	3
4	4
5	1, 2
6	1, 3
7	2, 3
8	1, 2, 3
9	1, 3, 4

Chart 3

Code	Required Manual Keypad Entries
0	No entries
1	Odometer entry
2	Manual entry
3	Odometer and manual entry
4	Vehicle PIN
5	Odometer and vehicle PIN
6	Manual entry and vehicle PIN
7	Odometer, manual entry, and vehicle PIN

- 3 Save your file.

Sequential Numbering Hint

When entering data into the Key # field, it is simplest and easiest to manage if you use sequential numbers. MS-Excel makes it easy to enter sequential numbers:

- 1 After you have entered the first two sequential numbers in A3 and A4, highlight these cells.
- 2 There should now be a tiny square on the bottom right of cell A4. Drag that square down to the row number equaling the number of vehicles you will be entering into the TopKAT, plus two. (that is, if you have 700 vehicles in your fleet, drag the square down to cell A702). The following graphic shows how this will look for the first few cells.

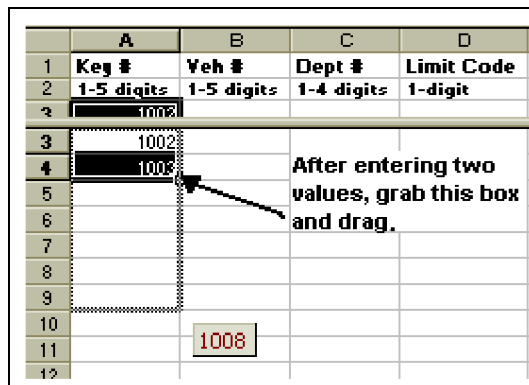

Transferring Vehicle Records from Excel to TopKAT

To transfer Vehicle Records from Excel to TopKAT, proceed as follows:

- 1 While in MS-Excel, highlight and copy all cells containing your vehicle information. Do not copy row 1 and 2 headers. Be sure to copy columns A through N, as you cannot see all columns displayed on one screen.
- 2 Open Microsoft Word®.
- 3 From the menu bar, select **Edit > Paste**.
- 4 Using your mouse, click anywhere within the table area.
- 5 From the menu bar, select **Table > Select Table**.
- 6 From the menu bar, select **Table > Convert Table to Text**. Select the required Paragraph marks and click **OK**.
- 7 Click on Align Left button on the menu bar.
- 8 Type the following at the top of the page:
A REC
V

Your screen should resemble the example shown below.

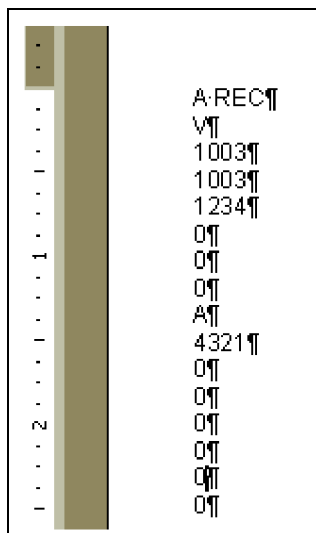

- 9 Save the file. Take note of where you have saved it.
- 10 From the menu bar, select **File > Save As**. Select Text only from the Save As Type list of options. Click **Save**.
- 11 Select the file. You are now ready to send your file to your TopKAT system.

- 12 Go to **Start > Programs > Accessories > Hyperterminal**.
- 13 Click on Hyperterminal
- 14 Type **TopKAT**; click **OK**.
- 15 If your TopKAT system is directly wired to your PC, select the COM port in the Connect Using box and click **OK**.
- 16 If you use a modem to communicate with your TopKAT system(s), select the modem in the Connect Using box and enter the TopKAT area code and phone number information in the other boxes, click **OK**.
- 17 Change Bits per second to match the TopKAT setting (commonly 9600). Click **OK**.
- 18 From the HyperTerminal menu, choose File, Properties, Settings tab, ASCII Setup button. Set Line delay to 500 milliseconds. Click **OK, OK**.
Note: Set the Line delay to 750 milliseconds when using Wireless Modem communication.
- 19 Sign on with your TopKAT system password (factory default is Gasboy), and press **ENTER**. You should see the CMD> prompt.
- 20 From the menu bar, select **Transfer > Send Text File**. Locate the text file, and click **Open**. The files will load. See the example below.

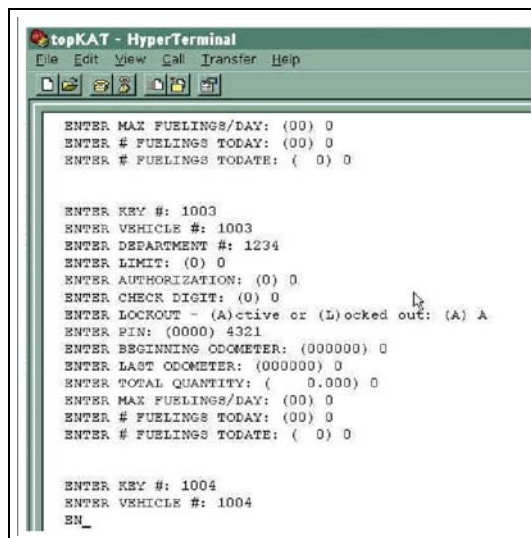

```
topKAT - HyperTerminal
File Edit View Call Transfer Help

ENTER MAX FUELINGS/DAY: (00) 0
ENTER # FUELINGS TODAY: (00) 0
ENTER # FUELINGS TODATE: ( 0) 0

ENTER KEY #: 1003
ENTER VEHICLE #: 1003
ENTER DEPARTMENT #: 1234
ENTER LIMIT: (0) 0
ENTER AUTHORIZATION: (0) 0
ENTER CHECK DIGIT: (0) 0
ENTER LOCKOUT - (A)ctive or (L)ocked out: (A) A
ENTER PIN: (0000) 4321
ENTER BEGINNING ODOMETER: (000000) 0
ENTER LAST ODOMETER: (000000) 0
ENTER TOTAL QUANTITY: ( 0.000) 0
ENTER MAX FUELINGS/DAY: (00) 0
ENTER # FUELINGS TODAY: (00) 0
ENTER # FUELINGS TODATE: ( 0) 0

ENTER KEY #: 1004
ENTER VEHICLE #: 1004
EN_
```

If you see error messages on your screen, as the information is loading, go to the menu bar, select **Call > Disconnect** and press **ENTER** to end the transfer.

Reasons for Errors

The system is expecting all of the information to be entered in exact order.

- When you copied your records from Excel, you did not highlight all of the columns.
- You mistakenly copied the header rows.
- You entered fields in your Excel form that exceeded the maximum length or maximum number.
- One of the records you are transferring already exists in your TopKAT system or on your list. (Key numbers and vehicle number/department combinations must be unique in the TopKAT system).

If your list contains all of the records you want in your TopKAT vehicle file, you can first use the TopKAT clear file command to erase all existing vehicle records so you can start with a clean download. To do this:

- 1 Sign back onto the system with the TopKAT password.
- 2 Do the following in sequence:
 - Type **CL F**
 - Press **ENTER**.
 - Type **1**
 - Press **ENTER**.
 - Type **YES**
 - Press **ENTER**.
 - Press **ENTER** again.

Creating Your TopKAT Manual Entry Records in Excel

To create TopKAT Manual Entry Records in Excel, proceed as follows:

- 1 Open MS-Excel and create a form (worksheet) that looks identical to the screen below.

	A	B	C	D	E	F
1	Manual Entry	Dept #	Lockout Status	PIN #	Total Qty.	Fuelings to Date
2	1-4 digits	1-4 digits	A or L	1-4 digits	1-8 digits	1-3 digits
3						
4						
5						

- 2 Enter your manual entry information starting in row 3 of the form. This is normally Employee information, but could also be Job #, Account #, Auxiliary #, Trip #, Driver #, Misc #.
 - Each row will be for one record. All columns must be filled in according to the field sizes shown in row 2.
 - To display the header rows, split the screen by pulling the tiny bar in the right corner of the Excel chart until it is below row 2.

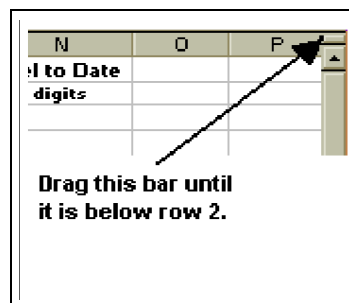

- You can use the MS-Excel drag, copy, and paste functions to quickly fill in the form.

The table below describes the data to be entered in the columns. If you need additional information on these fields, refer to the appropriate section of this document.

Column	Data	Enter
A	Manual Entry	1- to 4-digit number
B	Dept #	1- to 4-digit department number
C	Lockout Status	1-character lockout status code (A for active, L for locked out)
D	PIN #	1- to 4-digit personal identification number (PIN)
E	Total Qty.	8-digit (xxxxx.xxx) total quantity (Use 0 for this initial set up.)
F	Fuelings to Date	1- to 3-digit number for fuelings to date (Use 0 for this initial file set up.)

- 3 Save your file.

Transferring Manual Entry Records from Excel to TopKAT

To transfer Manual Entry Records from Excel to TopKAT, proceed as follows:

- 1 While in Excel, highlight and copy all cells containing your information. Do not copy row 1 and 2 headers.
- 2 Open Microsoft Word.
- 3 From the menu bar, choose **Edit > Paste**.
- 4 Using your mouse, click on the table.
- 5 From the menu bar, select **Table > Select Table**.
- 6 From the menu bar, select **Table > Convert Table to Text**. Select the required Paragraph marks, click **OK**.
- 7 Click on Align Left button on the menu bar.

- 8 Type the following at the top of the page:

A REC

E

Note: Although this field is normally E for Employee, your system could have been configured for Job #, Account #, Auxiliary #, Trip #, Driver #, or Misc. #. If this is the case, use E, J, A, T, D or M appropriately.

Your screen should resemble the screen below.

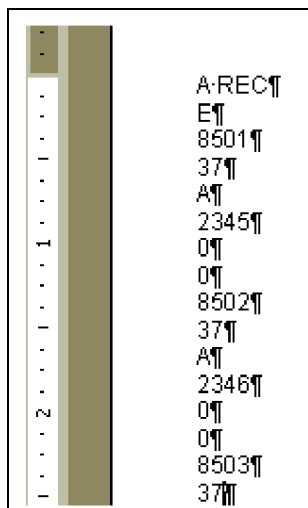

- 9 Save the file. Take note of where you have saved it.
- 10 From the menu bar, select **File > Save As**. Select Text only from the Save As Type list of options. Click **Save**.
- 11 Close the file. You are now ready to send your file to your TopKAT system.

- 12 Go to **Start > Programs > Accessories > Hyperterminal**.
- 13 Click on Hyperterminal
- 14 Type **TopKAT**, click **OK**.
- 15 If your TopKAT system is directly wired to your PC, select the COM port in the Connect Using box and click **OK**.
- 16 If you use a modem to communicate with your TopKAT system(s), select the modem in the Connect Using box and enter the TopKAT area code and phone number information in the other boxes, click **OK**.
- 17 Change Bits per second to match the TopKAT setting (commonly 9600). Click **OK**.
- 18 From the HyperTerminal menu, choose File, Properties, Settings tab, ASCII Setup button. Set Line delay to 500 milliseconds. Click **OK > OK**.
Note: Set the Line delay to 750 milliseconds when using Wireless Modem communication.
- 19 Sign on with your TopKAT system password (factory default is Gasboy), and press **ENTER**. You should see the CMD> prompt.
- 20 From the menu bar, select **Transfer > Send Text File**. Locate the text file, and click **Open**. The files will load. See the example below.

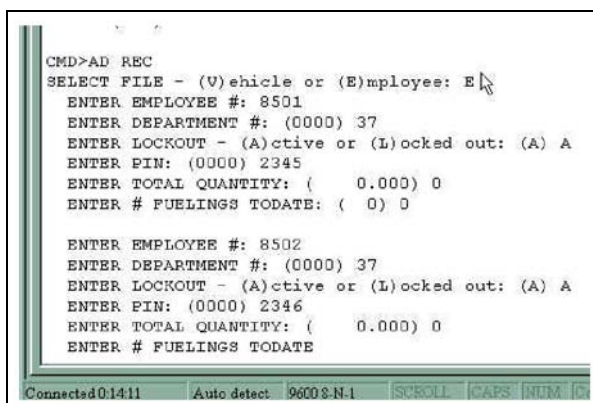

```
CMD>AD REC
SELECT FILE - (V)ehicle or (E)mployee: E
ENTER EMPLOYEE #: 8501
ENTER DEPARTMENT #: (0000) 37
ENTER LOCKOUT - (A)ctive or (L)ocked out: (A) A
ENTER PIN: (0000) 2345
ENTER TOTAL QUANTITY: ( 0.000) 0
ENTER # FUELINGS TODATE: ( 0) 0

ENTER EMPLOYEE #: 8502
ENTER DEPARTMENT #: (0000) 37
ENTER LOCKOUT - (A)ctive or (L)ocked out: (A) A
ENTER PIN: (0000) 2346
ENTER TOTAL QUANTITY: ( 0.000) 0
ENTER # FUELINGS TODATE

Connected 0:14:11 Auto detect 9600 2-N-1 SCROLL CAPS NUM C
```

This page is intentionally left blank.

Gasboy TopKAT Site Information Form

Reference MDE-4338 TopKAT Fuel Management System Operation Manual (formerly C35757).

GENERAL INFORMATION

Site No.: _____ (4 digits)

Poll Address: _____ (2 digits)

Default Term. Password: Yes ___ No ___

System ID: _____ (factory-loaded)

Password (Manager Key): _____ (4 digits)

Reas. Range: _____ (4 digits)

Odom. Retries: _____ (2 digits)

Invalid PIN Lockout: Yes ___ No ___

Select Field Name: Dept ___ Acct ___

Load Mode prompt will be set to **Standalone** for single TopKATs.

Load Mode prompt must be set to **Master** at the master unit and **Satellite** at each satellite unit.

Load PCU Type - (standalone or master only)

___ All 9800

___ 4-hose mechanical PCU(s)

___ 2-hose mechanical I/F

___ 9800 - mech (master only)

Select Entry Mode (set individually at master and each satellite)

___ Key only ___ Keypad only ___ Key/Keypad

MANUAL ENTRY CONFIG. (Select one)

Employee # ___ Job # ___ Account # ___ Auxiliary # ___ Trip # ___ Driver # ___ Misc. # ___

MANUAL ENTRY CHECK

Required: ___ Not Required: ___

MEASUREMENT UNITS

Distance: Miles ___ Kilometers ___ Hours ___

Rate: MPG ___ HPG ___

Quantity: Gallons ___ Liters ___ Litres ___

L/100KM ___ LPH ___

KM/L ___ HPL ___

Date Format: mm/dd/yy ___

yy/mm/dd ___

dd/mm/yy ___

Pump Timeout Mode: USA ___ International ___

VEHICLE FILE

Use the form on the reverse side of this page for your vehicle file data. For additional vehicles, you may make copies of this form. There is a maximum of 2000 vehicles.

TANK FILE

Number of Tanks: ___ (1 digit)

Tank No.	Prod. No.	Quantity	Last Delivery Amt	Last Delivery Date

PUMP FILE

Number of Pumps: ___ (1 or 2) Standalone only

Pump No.	Sat. No	Tank No.	Totalizer	Totalizer Reset Date

PCU FILE - STANDALONE

PCU Assignments: Pump #1 Slot: ___ Pump #2 Slot: ___ Pump #3 Slot: ___ Pump #4 Slot: ___

PCU FILE - MASTER/SATELLITE

Unit	# of Pumps	Base Pump # (BP)	Slot 1 (BP#)	Slot 2 (BP# +1)	Slot 3 (BP# +2)	Slot 3 (BP# +3)
Master						
Satellite 1						
Satellite 2						
Satellite 3						
Satellite 4						
Satellite 5						
Satellite 6						
Satellite 7						

TRANSACTION FILE

Load Transaction No.: ___

Record Error Transactions: Yes ___ No ___

Clear Transactions in Progress: Yes ___ No ___

Config Trans Logger: Enable ___ Disable ___

Clear Transaction File: Yes ___ No ___

Memory Full Protection: Yes ___ No ___

REPORTS

To verify all information is loaded correctly, you can obtain a hard-copy report either on the Logger or Reports Printer.

Complete the TopKAT Start-up Form and return it to Gasboy International to ensure full factory warranty.

This page is intentionally left blank.

Index

A

About Terminal Commands 87
 Access
 command mode 13
 Diagnostic Menu 72, 79
 enhanced diagnostics 99
 fuel 1
 inhibit 41
 keypad options 25
 LCD menu system 13
 Main Menu 30
 Manual Entry File 44
 modem feature 59
 PCMCIA socket/board 18
 PCU Setup 52
 printer 15
 product types 37
 Pump File 49, 50, 51
 Report Menu 65
 Setup Commands 30
 system 1
 Tank File 47, 48, 49
 Terminal Commands 88
 unattended 1
 Utilities Menu 75
 vehicle records 35
 Access Diagnostics 99
 Alert symbol 5
 application
 Excel 1, 3, 4, 6, 7, 8
 Word 4, 8
 authorization code 37, 40, 68, 89, 2

B

Barricading 5
 battery
 battery 77
 replace 12, 75, 77
 BULK FUELING 33, 91
 bulk fueling 21, 22, 33, 36, 91

C

Caution warnings 5
 Check
 Manual Entry 32, 69, 91, 105, 107

command

A I 88, 1
 A REC 89, 4, 8
 ADD TO INVENTORY 48
 Add to Inventory 47
 BEEPER TEST 82
 BULK FUELING 33
 CL F 29, 90, 6
 CL K 90
 CL TIP 90
 CLEAR FILE 42, 45
 Clear Trans File 56
 Clear Trans in Prog 56
 CO B 91
 CO LOG 13, 29, 55, 91
 CO MA 29, 91, 105, 107
 CO PC 29, 92, 93
 CO PI 94
 CO SY 29, 94, 95, 96, 97
 CO U 98
 DATAKEY READ 74
 DATAKEY TEST 83
 DE REC 98
 DEADMAN TIMER TEST 84
 DIAG 71, 79, 84, 99
 DIP SWITCH TEST 73, 81
 DIS PU 99
 DISPLAY TEST 73, 82
 displayed 25
 ED REC 99
 EN PR 29
 EN PU 100
 EX 100
 EXECUTE DEADMAN TIMER
 TEST 84
 H 100
 HEALTH LIGHT TEST 81
 HELP 1
 I F 29, 101
 I MOD 59, 101
 individual 25
 INITIALIZE FILE 42, 45, 49
 INVALID PIN LOCKOUT 32
 KEY READ TOTALIZER 73
 KEYPAD TEST 73, 83
 L DA 102
 L MO 102
 L OR 23
 L PA 103
 L PU 20, 21, 29, 103
 L RA 103
 L RET 104
 L TA 29, 104
 L TIM 104
 L TR 104
 LO DA 29
 LO MOD 59, 102
 LO TR 29
 LOAD DATE 31
 LOAD MODE 30
 LOAD MODEM 60
 LOAD ODOM RETRIES 32
 LOAD PASSWORD 31
 LOAD PCU TYPE 31
 LOAD POLL ADDRESS 31
 LOAD PUMP TABLE 20
 LOAD REAS RANGE 32
 LOAD SITE NO 31
 LOAD SYSTEM ID 31
 LOAD TIME 31
 Logger option 28
 M PO 105
 MANUAL ENTRY CONFIG 32
 MO PO 56, 105
 modem 59
 Move Trans Pointer 56
 P MOD 107
 PCMCIA BAK/
 RESTORE 75, 76, 77
 PCMCIA TEST 75, 85
 PORT TEST 74, 83
 PR A 106
 PR DA 105
 PR DEPTM 105
 PR DEPTV 106
 PR EV 106
 PR K 106
 PR KE 106
 PR LOC 107
 PR MA 107
 PR MOD 59
 PR PU 107
 PR SY 108
 PR TA 108
 PR TR 56, 105, 108
 PR V 108
 PRINT MODEM 60
 Print Transactions 56
 PRINTER TEST 86
 PROGRAM VERSION 74
 RAM TEST 72, 80
 RE ER 108
 ROM TEST 72, 80
 RUN 28, 29, 30, 109

- SE N 109
- SELECT ENTRY MODE 31
- SELECT FIELD NAME 32
- Setup 26
- start-up 26
- STOP 30, 109
- Stop 1
- SU I 110
- Subtract from Inventory 47
- terminal 25, 59
- TopKAT 5, 9
- TTY 1
- command mode 13, 29
- commands
 - SETUP 29
- Communications
 - Initiating 13
 - Interface PCB 87
 - Ports 12
 - Protocol 12
- communications
 - in event of problems 56
 - port 74
 - start 28, 29
- configurations
 - system 2
- CONFIGURE
 - PCUs 19
 - SYSTEM 19
- Configure 53
 - Logger 13
 - Master Unit 54
 - system parameters 29
- configure
 - bulk 91
 - logger 29, 91
 - manual 105, 107
 - manual entry 43
 - manual entry file 91
 - master 93
 - PCUs 92
 - satellite 93
 - system 26, 94, 95, 96, 97, 8
 - units 98
- configure PIN 94

D

- Danger warnings 5
- Diagnostic Menu
 - Access 72, 79
- Diagnostics
 - Access 99

- Disable
 - Config Trans Logger 57
 - Internal Modem 11
 - PCU Setup 53
 - Pump 51
 - Pump Switch Timer 20, 22
 - Report Printer 11
 - RS-485 Pump Stop Detection 14
- disable
 - Department Manual Entry Report 69
 - logger 91
 - Manual Entry Report 69
 - memory full protection 56, 105
 - pump 99, 1
- document, referenced
 - C35757 1
 - C35965 12
 - MDE-4319 9, 12
 - MDE-4338 1
 - MDE-4340 12
 - MDE-4341 12, 13
 - MDE-4490 25
 - MDE-4520 12, 61, 63

E

- Electrical
 - Shut-off 5
- Emergency
 - Electrical shut-off 5
 - In Case Of 7
 - Personnel (contacting) 6
- Enable
 - Config Trans Logger 57
 - Internal Modem 11
 - Memory Full Protection 100
 - Protection 100
 - Pump 51
 - Report Printer 11
- enable
 - logger 55, 91
 - memory full protection 56
 - pump 100
- enhanced diagnostics
 - Access 99
- Evacuation 5
- Explosions
 - Preventing 5

F

- Fires
 - Preventing 5

- flowchart 1
- Fuel Delivery
 - Record 24
- Fueling Sequence
 - Typical 22

I

- inhibit
 - Access 41

K

- Key Sequence
 - Dipstick Reading 24
 - Fuel Delivery 24
 - Supervisor 24
- key type 41, 74, 83, 1
- key types 1, 74
- keypad options
 - Access 25
- keypad setup menu 59

L

- Location 9

M

- Main Menu
 - Access 30
- Manual Entry
 - Check 32, 69, 91, 105, 107
- Manual Entry File
 - Access 44
- mode
 - command 29
- modem command string 59
- modem feature
 - Access 59
- modes of operation
 - command 13
 - direct printout 13

O

- ODOMETER
 - BEGINNING 40, 89
 - ENTER 33
 - LAST 40, 89
- Odometer 55
 - Beginning 35, 68
 - entry 37, 3
 - Last 35, 68, 83
 - Previous 83
 - range 1

- odometer 32, 66
 - beginning 42, 2
 - entry 22, 74
 - last 23, 42, 66, 2
 - reading 9, 22, 2
 - reasonable miles 103
 - re-prompted 104
 - retries 66
- Operating Environment 9
- P**
- PCU Setup
 - Access 52
- Personnel
 - Emergency (informing) 6
- Power 9
- product code 37
- product types
 - Access 37
- Pump File
 - Access 49, 50, 51
- R**
- Report Menu
 - Access 65
- S**
- Safety Information 5
 - Alert symbol 5
 - Barricading 5
 - Emergency electrical shut-off 5
 - Emergency personnel 6
 - Evacuation 5
 - NFPA regulations 5
 - Open flames 6
 - Preventing explosions and fires 5
 - Regulations 5
 - Replacement parts 5
 - Safety symbols 5
 - Shut-off 5
 - Signal words 5
 - Smoking 6
 - Sparks 6
 - Warning words 5
 - Working alone 6
- Safety symbols 5
- Setup Commands
 - Access 30
- setup menu
 - keypad 59
- Shut-off 5
 - Emergency electrical 5
- Signal words
 - Safety 5
- switch settings
 - 9800 13
 - CPU PCB 10
 - printer controller 16
 - Pump Control 20, 21
- system
 - configurations 2
- T**
- Tank File
 - Access 47, 48, 49
- terminal command 13
- Terminal Commands
 - About 87
 - Access 88
- terminal commands 19
- U**
- Utilities Menu
 - Access 75
- V**
- vehicle records
 - Access 35
- W**
- Warning words 5
- Warnings 5

Excel[®], Microsoft[®], and Word[®] are registered trademarks of Microsoft Corporation. TopKAT[™] is a trademark of Gasboy International.



© 2009 GASBOY
7300 West Friendly Avenue · Post Office Box 22087
Greensboro, North Carolina 27420
Phone 1-800-444-5529 · <http://www.gasboy.com> · Printed in the U.S.A.
MDE-4338A TopKAT[™] Fuel Management System Operation Manual · February 2009